

srr

Recycling and Recovery
International Trade Fair

09-11
Jun
2026

ifema.es

Regenerating
resources for
future generations

Exhibitor's Guide and Specific Rules of
Participation

Promueve:



Colaboran:



AENOR



INDEX

1. HOW TO PARTICIPATE. REGULATIONS

- 1.1 Dates. Timetable and venue Sectors convened
- 1.2 What do I have to do to participate?
- 1.3 Contracting and allocation of spaces
- 1.4 Participation modalities and exhibition areas
- 1.5 Liveconnect: the digital platform to which you have access with your Exhibitor Plan.
- 1.6 Your space at the fair. Types of stands. Regulations and assembly
- 1.7 Participation fees
- 1.8 Deadlines and forms of payment
- 1.9 Specific rules of the fair
- 1.10 Exhibitor's calendar

2. MANAGE YOUR PARTICIPATION

- 2.1 Expo Zone. Manage your participation and your space
Contracting additional services. E-commerce
- 2.2 Registration of co-exhibitors
- 2.3 Passes and invitations. Visas. Vouchers and discounts
- 2.4 Other relevant information.
- 2.5 Floor plan
- 2.6 Frequently asked questions

3. PROMOTE AND MONETIZE YOUR PARTICIPATION

- 3.1 Exhibitor Catalog
- 3.2 Networking
- 3.3 Invitations for your clients and contacts.
- 3.4 Publish your news and novelties. RRSS and WEB
- 3.5 Outdoor and digital advertising
- 3.6 Room rental

4. SUSTAINABILITY MANAGEMENT AT IFEMA MADRID

5. CONTACT US

1.1 Dates. Time and place of celebration. Sectors convened

SRR will take place at the IFEMA MADRID exhibition center from **June 9 to 11, 2026** from 10 am to 7 pm. On June 11 until 3 pm. Exhibitors will be able to access the venue from 9 am and leave it before 7.30 pm.

The virtual event through the Liveconnect platform will be open from March 2 to July 1, 2026. The character of the fair is professional.

Sectors convened:

1. Machinery for recycling and recovery

Equipment and technologies for waste treatment: shredders, compactors, separators, presses, among others.

2. Electronic waste treatment (WEEE)

Solutions for the management of electrical and electronic waste, including disassembly, decontamination, sorting and recycling.

3. Energy recovery

Technologies for converting waste into energy sources, such as biogas, incineration with energy recovery or gasification.

4. Ferrous metals recycling

Processes and machinery for the recovery, separation and treatment of metals such as iron and steel.

5. Non-ferrous metals recycling

Specific technologies for recycling aluminum, copper, zinc, lead and other non-ferrous metals.

6. Recycling of plastics, paper, glass and wood

Equipment and solutions for non-metallic waste treatment, automatic sorting, washing and reuse.

7. End-of-life vehicles (ELV)

Systems and machinery for the comprehensive treatment of end-of-life vehicles: decontamination, dismantling, fragmentation and recycling of components.

8. Environmental services and consultancy

Companies offering advice, planning, certification and legal and technical solutions in circular economy and waste management.

9. Research, innovation and digitalization

Space for startups, universities and technology centers presenting advances in automation, AI, robotics and waste traceability

10. Associations, institutions and technical publications

Public bodies, NGOs, industry associations and specialized media that promote sustainability and best practices in the sector.

1.2 What do I have to do to participate?

The application for participation is initiated by completing, within the established deadline, the online **Participation Application** form accessible from the [fair's website](#) along with proof of payment of the corresponding registration/reservation fee. This form will allow us to inform you in the most complete way and make you a proposal of participation. You can check the reservation and payment deadlines on the form itself and in the Exhibitor's Calendar. The registration/reservation fee may be used as compensation for expenses incurred in making the application and proposal and will be applied as part of the total payment for participation.

The submission of the Application to participate implies full acceptance of the [General Rules of Participation in Exhibitions organized by IFEMA MADRID](#), the technical annexes, the Specific Rules of this edition and the provisions, generic or specific, established by the organization of the fair. The exhibiting company is the company that will participate in the fair, in whose name the application for participation as exhibitor is filled in.

In order to apply for participation in the fair, it is a requirement that the exhibitor's activity, whether it is a company, public or private organization, is included within the sectors covered by the fair.

By clicking on the submit application button, the exhibitor confirms to IFEMA MADRID that he/she is seriously interested in participating as an exhibitor and in receiving a proposal.

From the same application form, if the process is not completed, it is possible to request information and quotes, which does not imply a request for an offer and does not require payment of a reservation fee

1.3 Contracting and allocation of space.

The decision to accept the exhibitor will be at the discretion of IFEMA Madrid, taking into account the purpose of the fair and the availability of space.

IFEMA Madrid will make one or more proposals for space/location depending on the type of participation and/or type and size of stand requested. This proposal constitutes a contracting offer. If the contracting party accepts the offer/quote in writing/email/signature or during the space selection meeting, he/she will be formalizing the contract for participation in the fair, which constitutes a binding commitment that cannot be revoked by the applicant.

The space will be awarded upon acceptance, in writing, by the exhibitor.

The exhibitor will receive the exhibition contract with the statement of accounts and the location plan and dimensions of his/her stand/s and from that moment on he/she will be able to access the Zona Expo customer portal to manage his/her participation.

1.4 Participation Modalities

- **Exhibitor:** is the individual or legal entity that has a space at the Fair. The exhibiting company is the one in whose name the application for participation as an exhibitor is completed.
The exhibitor in the **general modality** has the option of contracting a modular stand, either “basic turnkey stand” or “premium turnkey stand”, or to contract only the space to build its own “free design stand”. The exhibitor in **the Start up modality** can hire the corresponding Start up modular stand
- **Co-exhibitor:** an individual or legal entity that participates in the stand of an exhibitor, contracting directly with him. The exhibitor must register their co-exhibitors from the customer portal Zona Expo and each co-exhibitor must complete an application for participation as a co-exhibitor at the fair.

1.5. Your Exhibitor Plan. Liveconnect: the digital platform you have access to with your Plan.

Conecta Exhibitor Plan

Participation as an exhibitor at the fair requires hiring the CONECTA EXHIBITOR PLAN 320€ + VAT (1)

This concept includes the following services:

- Registration as a participating company
- Company file with general information about the company, products and services
- Registration of 3 people in the digital event for networking and scanning passes
- Registration of 20 products Inclusion of 1 promotional video in your participant file.
- Wifi 3 users

Participation as exhibitor or co-exhibitor in the fair requires the contracting of the CONECTA EXHIBITOR PLAN 320€ + VAT.

Connection functionalities with other users to generate business opportunities for 3 users (in Liveconnect):

- Search for new contacts among registered visitors and exhibitors
- Communication with contacts (chat and videoconference)
- Organization of personal online and face-to-face meetings with contacts
- Preparation of company meetings at the trade show booth to optimize time Scanning of visitor passes at the trade show
- Downloading of the contact list with your data

Participation as an exhibitor in the Start up modality requires the Conecta LITE Exhibitor Plan.

Conecta LITE display plan

RATE.....216€ + VAT(1)

- Registration as a participating company
- Company profile with general information about the company, products and services
- Registration of 1 person in the community for networking
- Registration of 1 product Inclusion of 1 promotional video in your participant profile
- Wifi for 3 users

What will you find on liveconnect ?

Liveconnect is the digital ecosystem **that fosters connections with other professionals**, facilitates the preparation of meetings, offers exclusive content and activities and generates business opportunities.

Business and networking

Identify leads to generate business and schedule high value meetings.

Post-fair ecosystem

Activity and visibility after the fair: access and share content, participate in challenges and much more.

Positioning

Highlight your company and increase the visibility of your offer.

UPGRADES

Exhibitors with a booth and their co-exhibitors have the option of contracting the following additional upgrades, which add functionalities to the CONECTA plan:

Impact Exhibitor Plan

UPGRADE RATE410€ + VAT (1)

Everything included in the CONECTA plan plus:

- Preferential display on the platform as a featured exhibitor.
- Unlimited registration of people with networking in the digital event.
- Unlimited registration of products
- Highlight 3 products/services with preferential display (*you must communicate to the management of the event the products you want to highlight). Scanning of visitor passes
- Publication of 1 news item in the corresponding section within the platform (*must be sent to the management of the event).

1. HOW TO PARTICIPATE. REGULATIONS

What can I do from my Exhibitor area in Liveconnect?

- Update my company's data visible in the web catalog and in SRR Liveconnect.
- Add my products and services, which will be visible in SRR Liveconnect.
- Register users of my team to access the digital event SRR Liveconnect.
- Manage the agenda of the exhibiting company and company meetings at my booth at the fair.

What can I do in the SRR Liveconnect digital event?

- Search for contacts of interest in the professional network
- Request and accept to be contacted for chatting and videoconferences
- Request and/or accept appointments for professional meetings at my booth at the fair or by videoconference.
- Complete my professional profile as a user of the platform and my personal availability agenda for meetings.
- View information about the offer of other exhibitors.
- Consult the activities and conferences, both on-site and online, and note them in my agenda.- Scan visitor badges at the fair.
- Download my contact list

1.6 Your space in fair. Types of stands. Regulations and assembly

TYPES OF STAND

Types of assembly for each area

- **Turnkey stand BASIC**
- **Turnkey stand PREMIUM**
- **Turnkey stand START UP**
- **Free design stand:** Floor only. Only contracting space to build your own stand whose assembly project must be approved by IFEMA MADRID.

Please remember that you must pay the corresponding assembly fees.

Participation with a stand at the fair requires the contracting of the following general services associated with the stand:

- ❖ Liability insurance (covers up to 60.000€)(*)
- ❖ Multi-fair insurance (covers up to 50.000€)(*)
- ❖ Minimum electricity consumption (0,13 kW/sq.m (*)
- ❖ Assembly fees (service included in the turnkey stand)(*)
 - **Type A:** spaces without decoration, or occupied by carpeting or dais
 - **Type B:** basic modular stands in aluminum or similar
 - **Type C:** modular aluminum design stands, carpentry stands and other materials

(*) Services already included in the Basic and Premium turnkey stand.



BASIC TURNKEY BOOTH

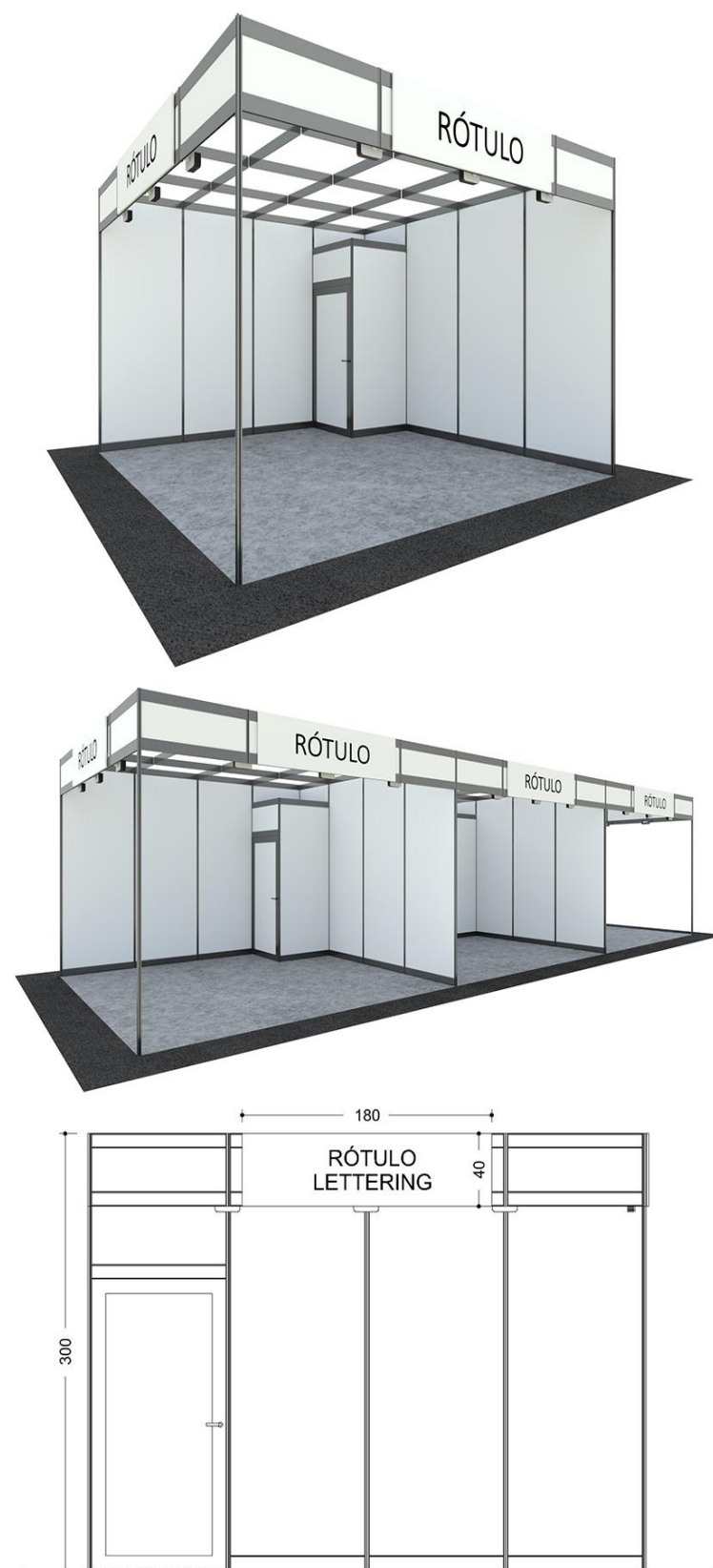

STAND

Stand open to one or several aisles depending on location. Aluminum structure in gray color and melamine walls.

WAREHOUSE with lockable door in the following proportion:

Up to 16 sq.m.....1x1 m
 From 16.5 to 32 sq.m2x1 m
 From 32.5 sq.m.....3x1 m

CARPETING TYPE FAIRGROUND

The default color of the carpet is leaf green.



ELECTRICAL ENERGY AND LIGHTING

- Lighting by means of LED spotlights on rails at a rate of 1 spotlight every 3 sq,m of stand.
- Electrical panel with magneto-thermal differential with built-in 500W socket, prepared for a power of 130W/sq.m.

SIGNAGE

Standardized lettering with exhibitor's name editable in EXPO ZONE and booth number. **Maximum 20 characters.**

If the exhibitor's name field is not completed in the EXPO ZONE, it will be labeled with the Fair Name of the Participation Application. The exhibitor must indicate the company name chosen for the sign **before May 20, 2026.**

FURNITURE (service included in stands of 16 sq.m or more):

- 1 White Dom Table (6RL02001)
- 3 Madrid Chairs (6RL01001)
- 1 Tana Counter 100X50X100 cm (6RL08003)
- 1 Lima Stool (6RL01009)



OBLIGATORY CONTRACTING

In addition, participation as an exhibitor implies the mandatory contracting of the CONECTA EXHIBITOR PLAN (former Marketing and Communication pack): 320 Euros + VAT (1)

SERVICES INCLUDED

- Daily cleaning of the stand (Type A, once a day).
- Set-up fees included in the price.
- Multi-fair and civil liability insurance included in the price.
- Minimum electricity consumption (0,13 Kw /sq.m).
- 1 parking card valid for one car, during set-up, fair and dismantling (to be picked up at the fair, at Exhibitor Service).

CLEANING TYPE A:

First cleaning with removal of the plastic covering the carpet and daily cleaning of the floor and collection of the contents of the garbage cans. It does not include the cleaning of the exhibits.

ASSEMBLY PLAN

Your set-up plan can be viewed in the EXPO ZONE with the location of the warehouse and other services included. In addition, you can monitor the status of the plan and comment on it, in case you need to make any changes.

ADDITIONAL SERVICES

Customize your modular booth with our Stand Graphic Decoration Service decoraciongrafica@ifema.es

DRAWING AS A GUIDE. It is not allowed to drill holes or nail. It is allowed to paste with adhesive tape whose removal does not damage the panels. It shall be adapted to the dimensions of the space allotted.

REMARKS: - All services or modifications to be introduced from these characteristics shall be at the exhibitor's expense. - The elimination or substitution, by the exhibitor, of any training element of the modular stand does not imply a reduction in the cost. - The distribution of all the elements that make up the stand, the extras requested, as well as the structural elements necessary for the support of the stand, will be adapted to the needs of the exhibitor, as long as it is technically feasible and the plan with the pertinent indications is received fifteen days before the first day of the beginning of the assembly. Once the stand has been assembled, any changes in the location of all the elements that have not been communicated on the established date will be invoiced. - All the material used, both structural and electrical, is rented and any deterioration will be invoiced according to the current rates. - In addition, any exhibitor may hire elements listed in the IFEMA Services Catalogue.

1. HOW TO PARTICIPATE. REGULATIONS

SRR

PREMIUM TURNKEY BOOTH

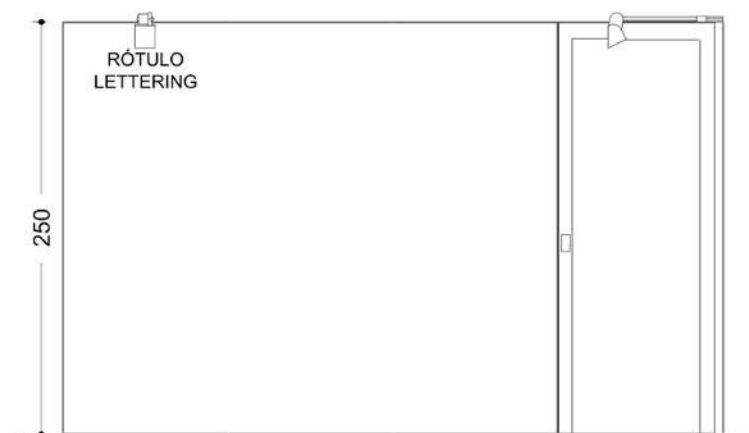
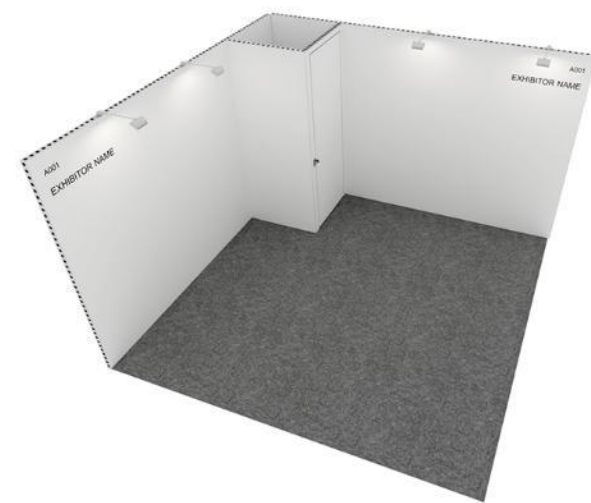

STAND

Stand open to one or more aisles according to the plan of adjudication. Structure: 2.5 m. high aluminum frames with white canvas walls. The change of color will be invoiced as an extra complement, upon request of budget.

WAREHOUSE with lockable door in the following proportion:

- Up to 23.5 sq.m.....1x1 m
- From 24 to 31.5 sq.m.....2x1 m
- From 32 sq.m3x1 m

FAIR TYPE MOUQUET sustainable, flame retardant and plastic coated. To be chosen at the Expo Zone **before May 20, 2026** from the following colors. Default will be leaf green.



ELECTRICAL ENERGY AND LIGHTINGLED

- spotlights on rails at a rate of one spotlight every 4 sq.m of booth to be distributed along the perimeter. In case you want to hire extra lighting and/or reticulated ceiling, you can do it through the Ecommerce.
- Electric panel with differential, circuit breaker and a 500W plug base incorporated, prepared for a power of 130 W/sq.m.
- If you need a specific distribution of the spotlights, please indicate it in the plan to be uploaded in your Expo Zone together with the rest of the needs: location of the warehouse, colors, etc.

SIGNAGE

Standardized lettering with exhibitor's name editable in EXPO ZONE and booth number. **Maximum 20 characters.**

If the exhibitor's name field in the EXPO ZONE is not filled in, it will be labeled with the Fair Name of the Participation Application. The exhibitor must indicate the company name chosen for the sign **before May 20, 2026.**

SEE RATES

FURNITURE (service included in stands of 16 sq.m or more):

- 1 White Dom Table (6RL02001)
- 4 Madrid Chairs (6RL01001)
- 2 Tana Counter 100X50X100 cm (6RL08003)
- 1 White Duero Wastebasket (6RL04003)
- 1 Lima Stool (6RL01009)
- 1 White Indo Coat Rack (6RL06001)
- 1 White Amazonas Bookcase (6RL07004)



OBLIGATORY CONTRACTING

In addition, participation as an exhibitor implies the obligatory contracting of the PLAN CONECTA (former Marketing and Communication pack).

SERVICES INCLUDED

- 1 parking card valid for one car, during set-up, fair and dismantling (to be picked up at the fair, at the Exhibitor Service Center).
- Cleaning of the stand once a day (Type A), first cleaning with removal of the plastic covering the carpet and daily cleaning of the floor and collection of the contents of the garbage cans. It does not include the cleaning of the exhibits.

INSTALLATION PLAN You can visualize your set-up plan in the EXPO ZONE, with the services included. In addition, you can monitor the status of the plan and make comments on it, in case you need to make any changes.

ADDITIONAL SERVICES

Customize your modular booth with our Stand Graphic Decoration Service standspremium@ifema.es

ORIENTATIVE DRAWING. It is not allowed to drill holes or nail. It is allowed to paste with adhesive tape whose removal does not damage the panels. It shall be adapted to the dimensions of the space allotted.

REMARKS: - Any services or modifications that may be required based on these characteristics shall be at the exhibitor's expense. - The elimination or substitution, by the exhibitor, of any formative element of the modular stand does not imply a reduction in the cost. - The distribution of all the elements that make up the stand, the extras requested, as well as the structural elements necessary for the support of the stand, will be adapted to the needs of the exhibitor, as long as it is technically feasible and the plan with the pertinent indications is received fifteen days before the first day of the beginning of the assembly. Once the stand has been assembled, any changes in the location of all the elements that have not been communicated on the established date will be invoiced. - All the material used, both structural and electrical, is rented and any deterioration will be invoiced according to the current rates. - In addition, any exhibitor may hire elements listed in the IFEMA Services Catalogue.

1. HOW TO PARTICIPATE. REGULATIONS

SRR

PREMIUM STAND+START UP

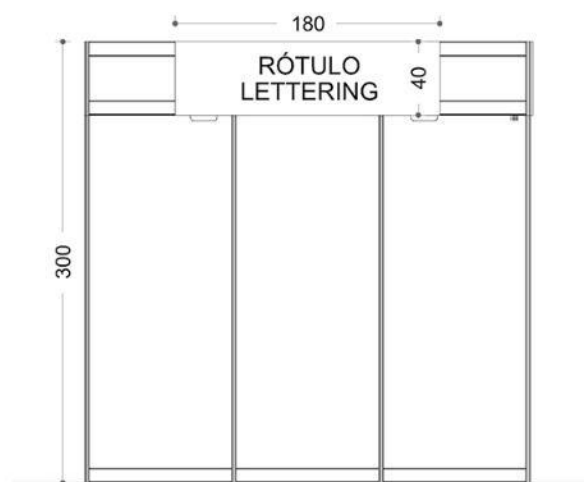
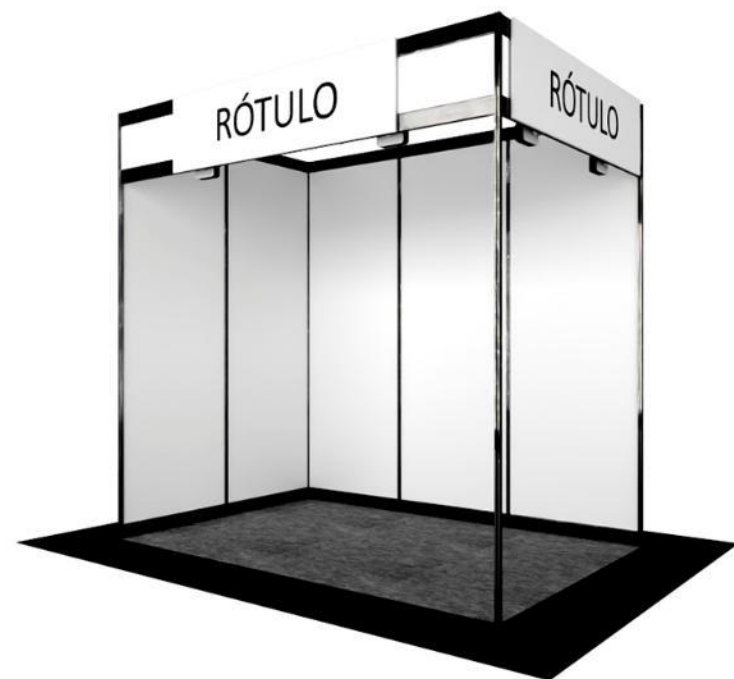

STAND

- 6 m² stand open to one or more aisles depending on location.
- Structure made of chipboard panels painted in matte white plastic. Other colors to choose from in the Exhibitor Area include black and gray.

EXHIBITION CARPET

The default color will be marbled gray.



ELECTRICITY AND LIGHTING

- Lighting provided by LED spotlights on rails, with one spotlight for every 3 m² of stand space.
- Electrical panel with residual current device, circuit breaker, rated for 130W/m².

FURNITURE (service included in stands of 6 m² and above):

- 1 Dom Blanca table (6RL02001)
- 3 Madrid chairs (6RL01001)
- Tana counter 100X50X100 cm (6RL08003)



MANDATORY CONTRACTING

In addition, participation as an exhibitor implies the mandatory contracting of the **CONECTA LITE PLAN**: €216 + VAT.

SERVICES INCLUDED

- Multiferia Insurance and Civil Liability.
- Minimum electricity consumption (0.13 kW x m²).
- Daily cleaning of the stand (once a day).
- One parking card valid for one car during assembly, the fair, and disassembly (to be collected at the fair, at Exhibitor Services).

TYPE A CLEANING:

Initial cleaning with removal of the plastic covering the carpet, daily cleaning of the floor, and emptying of waste bins. Does not include cleaning of exhibited items.

SIGNAGE

Standardized signage with the exhibitor's name and stand number on each aisle-facing side (maximum 36 characters). The deadline for requesting signage is **May 20, 2026**.

ADDITIONAL SERVICES

Customize your modular booth with our Booth Graphic Decoration service decoracióngrafica@ifema.es

GUIDELINE DRAWING. No holes may be made and no nails may be hammered in. Adhesive tape may be used provided that it can be removed without damaging the panels. The display must fit within the space allocated.

COMMENTS • All services or modifications to be made to these specifications shall be paid for by the exhibitor. • The removal or replacement by the exhibitor of any component of the modular stand shall not entail a reduction in cost. • The layout of all the elements that make up the stand, any extras requested, and the structural elements needed to support the stand will be adapted to the exhibitor's needs, as long as it's technically feasible and the plan with the relevant instructions is received fifteen days before the first day of assembly. Once the stand has been assembled, any changes to the location of any elements that have not been communicated by the established date will be invoiced. • All materials used, both structural and electrical, are rented and any damage will be invoiced according to the current rates. • In addition, any exhibitor may contract elements that appear in the IFEMA Services Catalog.

REGULATIONS AND ASSEMBLY OF YOUR SPACE

ASSEMBLY AND DISASSEMBLY

All companies will be obliged to assemble their stand, including at least the dividing walls with the pavilion wall and with the adjoining stands, depending on their location.

The assembly of free design stands can be done:

- ✓ From **June 4 to 5** the assembly schedule will be from 8:30 am to 9:30 pm.
- ✓ On **Saturday 6** the assembly will take place from 8:30 am to 7:30 pm.

The delivery of modular stands contracted with IFEMA MADRID will take place on **June 7 from 8.30 am**.

The occupation of the space will not be authorized and the modular stand will not be delivered to the exhibitor who has not paid in full the contracted space and the expenses of the requested services.

The entry of merchandise and decoration material may take place on **June 7 and 8 from 8.30 am to 9.30 pm. On June 8 from 7 pm onwards**, entry will only be possible through the pedestrian gates, closing the goods gates to proceed with the installation of recyclable carpeting.

The exit of goods and decoration material may take place on **June 11 from 3.30 pm to 9.30 pm. From 3.30 pm to 4.30 pm**, exit will only be possible through the pedestrian gates to proceed with the removal of recyclable carpeting. After this time, the merchandise gates will be opened until 9:30 pm.

Stands may be dismantled on the following days: **June 12 from 8.30 am to 9.30 pm. And on the 13th from 8.30 am to 7.30 pm.**

General assembly regulations

For **safety** reasons, and as a general and permanent preventive measure due to the concurrence of activities, **it is mandatory to wear a protective helmet, high visibility vest and safety shoes during the assembly and disassembly phases of fairs and events in all exhibition areas.**

During assembly, it is not necessary to carry passes; therefore, there are no assembler's passes.

No assembly work may begin without the prior completion and submission to IFEMA of the Protocol "Prevention of Occupational Risks and Coordination of Business Activities" available on the IFEMA MADRID website ifema.es -Exhibitors -Participation Regulations -Forms (Article 15 of the general rules for participation in events organised by IFEMA MADRID. available on the IFEMA MADRID website ifema.es ifema.es -Exhibitors -Participation Rules -Forms (Article 15 of the general rules of participation in events organized by IFEMA MADRID).

Rules for the circulation and parking of vehicles during the event: inside the fairgrounds it is expressly forbidden to keep vehicles parked in the loading and unloading areas, so that they can only park in the areas provided for this purpose, paying the corresponding fee if applicable. Once the event has opened, it is not allowed to circulate with any vehicle inside the halls and the avenue, unless expressly authorized by IFEMA MADRID (article 14 of the general provisions of the General Rules of Participation of IFEMA MADRID).

Management of waste and assembly and exhibition materials: all companies participating in the assembly and dismantling of stands at the fair/event must manage, as directly responsible, the waste they generate for its removal within the deadlines set. IFEMA MADRID will make available the possibility of hiring containers to facilitate the selection and removal of waste and will supervise the same (see rates in the Expo Zone Customer Portal, in Contracting Services, section on cleaning and waste containers).

The exhibitor shall lose any right to claim for loss or damage to materials still remaining in the exhibition areas of the pavilion at the end of the term and shall bear the costs related to their removal, which will be invoiced by IFEMA MADRID in accordance with the established rates (see art. 35 of the general regulations for exhibitors' participation in events organized by IFEMA MADRID).

SPECIAL AUTHORIZATIONS

On the ifema.es website, you will find a list of other services, regulations and forms that may be of interest to you:

Communication for catering at stands.

- Occupational risk prevention and coordination of business activities.
- Application for authorization of private security guards at stands.
- Authorization request for wifi installation.
- Authorization request for antenna cabling.
- Request for authorization to hang structures/rigging.

<https://www.ifema.es/en/support/exhibitors-ifema-fairgrounds>

REGULATIONS AND ASSEMBLY OF YOUR SPACE

Installation of recyclable carpeting in common areas: in line with IFEMA MADRID's commitment to the 2030 SDGs (United Nations Sustainable Development Goals), as indicated in the [Guide for Sustainable Participation in Fairs and Events](#), and with the aim of optimizing the process of installation and removal of recyclable trade fair carpeting for subsequent reuse and consequent elimination of the protective plastic at source, the times of entry and exit of goods must be adapted to these processes and will be reflected in the corresponding point. Thank you for your collaboration with our environmental commitment, and with the aim of optimizing the process of installation and removal of recyclable carpet for later reuse and consequent disposal of the protective plastic at source, the schedules of entry and exit of goods must be adapted to these processes and will be reflected in the corresponding point. Thank you for your collaboration with our environmental commitment.

IFEMA MADRID carpets the aisles throughout the fair and, for reasons of sustainability, does so with reusable strips of standard sizes and, as a result, leaving a small strip of carpet free on the edges of the aisle/s that border the stands. **These non-carpeted strips are part of the aisle and not of the stands and therefore the exhibitor is not authorized to cover or decorate them.** We request the exhibitor's cooperation in respecting this decision; IFEMA MADRID staff will monitor compliance as far as possible, and will demand the removal of any carpeting that invades these strips and, if, despite the controls, **the strip is invaded, the invaded aisle space will be invoiced to the exhibitor as space.**

Turnkey stands. Regulations and customization.

All modular stands that include interior decoration with panels, profiles, totems, platforms, trusses, etc., are REQUIRED to **UPDATE their project in THEIR EXPO ZONE before May 8, 2026.** The elimination or substitution, by the exhibitor, of any element of the modular stand does not imply a reduction in cost. All the material used, both structural and electrical, is rented and any deterioration will be invoiced according to the current rates.

The distribution of all the elements that make up the stand, the extras requested, as well as the structural elements necessary for the support of the stand, will be adapted to the needs of the exhibitor, as long as it is technically feasible and the plan with the pertinent indications IS UPLOADED IN THE EXPO ZONE 1 month before the beginning of the assembly: May 4, 2026.

CUSTOMIZE YOUR STAND WITH US: GRAPHIC DECORATION FOR STANDS

Customize your modular stand with the image of your brand, to generate maximum impact on visitors. We offer a wide range of graphic materials (vinyl, foam, Forex, canvas ...) versatile and adaptable to all elements of your stand (walls, furniture, fronts, banners, displays ...). Ask for more information and quotation. Our specialized team will follow up the production and installation. decoraciongrafica@ifema.es

For premium stand contact: standspremium@ifema.es

Once the stand has been assembled, any changes in the location of all the elements that have not been communicated on the established date will be invoiced.

To contract services, you must do it through our online channel, which you can access from the following link: [Commerce](#).

Free design stands. Regulations and assembly

Companies that opt for the free construction of their stands must SUBMIT THEIR EXPO ZONE the project for approval **before May 4, 2026**.

If your project includes a rigging structure, you must send a specific project to rigging@ifema.es before May 4, 2026.

Assembly rights

The company in charge of the assembly work of a stand must pay IFEMA MADRID, before starting such work, the assembly fees corresponding to the services rendered during the period of assembly and dismantling of the Fair. In the event that, as the exhibitor, you wish to assume the payment of these assembly fees and have them included in your invoice, you must contract them at the Expo Zone.

In order to be more efficient and provide a better service, avoiding incidents in the assemblies, **IFEMA MADRID has begun to apply a last minute surcharge to the hiring of assembly rights, as happens with the rest of our services.**

This surcharge increases the price by 25% when the contracting is made during the week prior (7 days before) to the start of the assembly, during the assembly, celebration and disassembly.

We remind you that the assembly fees apply to free design assemblies and that they can be contracted with a 5% discount if the contracting is made up to 30 days before the beginning of the assembly of the fair.

Segunda planta.
Máxima ocupación segunda planta.

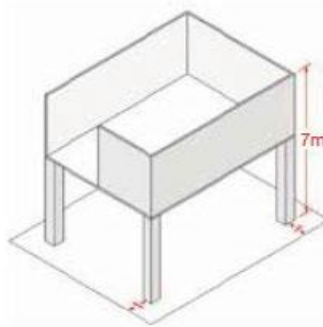

Normativa de alturas.
Máxima ocupación espacial a ocupar con cualquier elemento.

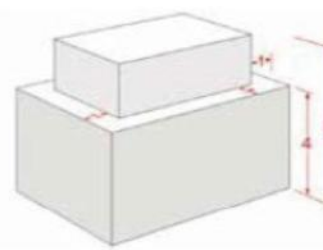

Cerramientos.

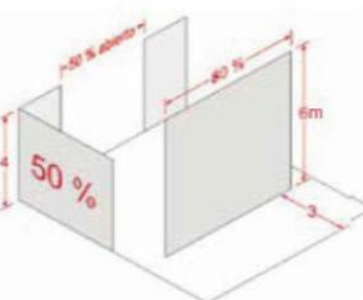

SPECIFIC ASSEMBLY RULES FOR FREE-DESIGN STANDS

Height

- Maximum authorized height in perimeter line: 4 m.
- To be able to raise or hang any decorative element at a maximum height of 6 m, it is necessary to set back 1 m inwards around the entire perimeter.
- This possibility does not exist in the connecting cores between halls, nor on the entrance sides of Halls 9 and 10.
- Construction elements, decoration and spotlights may not protrude more than 50 cm from the allotted space and from a minimum height of 2.5 m.

Blind enclosures in the perimeter environment

- Blind perimeter enclosures may not exceed 50% of each corridor façade.
- For longer enclosures, they must be set back a minimum of 3 m inwards and may not exceed 80% of the length of the façade.

Second floor

- The permitted height for two-story stands in pavilions is 7 m (23 ft). The second floor must be set back 1 m around the perimeter of the stand.
- In the connecting cores between halls and in the side entrance areas to Halls 9 and 10, the construction of a second floor is not permitted.
- Exhibitors must present a certificate specifying the dimensions, the load of use and the capacity, being the sole responsibility of the exhibitor to comply with the limits established therein.

The interpretation and application of the regulations for each particular case is the responsibility of IFEMA MADRID, who reserves the right to make exceptions if deemed necessary, based on respect for the general perspective of the event and the visibility of neighboring stands.

DESIGN YOUR STAND WITH US

In addition to turnkey stands, we offer you a complete stand design service, with our guarantee and fully adapted to your needs. We take care of the planning of your space, design, assembly and disassembly. Request, free of charge and without obligation, a project adapted to your needs by sending an email to standbuilding@ifema.es.

To contract services, you must go through our online channel, which you can access from the following link: [Commerce](#).

1. HOW TO PARTICIPATE. REGULATIONS

1.7 Participation Fees

TYPE OF SPACE	TARIFA
Floor only: Up to 50.00 sq.m	167,00€/sq.m + VAT (1)
Floor only: from 50.5 to 150.00 sq. m	157,30/sq.m + VAT (1)
Floor only: from 150.5 to 300.00 sq.m	150,00€/sq.m + VAT (1)
Ground only: More than 300.00 sq.m	128,40/sq.m + VAT (1)
BASIC turnkey booth: 16 sq,m	4.100,00€ + VAT (1)
sq.m additional turnkey booth BASIC	235,00€/sq.m + VAT (1)
Turnkey stand PREMIUM: 16 sq.m	5.459,00 € + VAT (1)
Turnkey stand PREMIUM: 32m sq.m	10.918,00€ +VAT (1)
SQ.M adic. turnkey stand PREMIUM from 32,5 sq.m	298,70€/sq.m + VAT
Additional SQ.M turnkey booth PREMIUM up to 32 sq.m	309,00€/sq.m +VAT
START UP Stand (6 sq.m)	1.750,00 +VAT

SERVICES	RATES
Liability insurance (covers up to 60.000€)	72,84€ + VAT (1)
Multiferia insurance (covers up to 50.000€)	69,15€ + VAT (1)
Minimum electrical energy consumption (0.13 kW/sq.m)	7,65€/ sq.m + VAT (1)
Assembly rights	
Type A: spaces with no decoration, or occupied by carpeting or flooring	2,77€/sq.m + VAT (1)
Type B: basic aluminum modular stands or similar.	5,56€/sq.m + VAT (1)
Type C: modular aluminum design stands, carpentry stands and other materials.	8,85€/sq.m + VAT (1)

CONECTA EXHIBITOR PLAN (former Marketing and Communication pack + Liveconnect) Up grade to PLAN IMPACTA 410,00€ + VAT CONECTA LITTE EXHIBITOR PLAN 216,00+ VAT	320€ + VAT (1)
Coexpositor high rate	320,00€ + VAT (1)
Additional exhibitor passes	6€/ud. +VAT (1)

1.8 Payment terms and methods

DATES FOR PAYMENT

➤ **When sending the Participation Application Form**, the space reservation fee of 500, 00€ will be paid.

February 8, 2026: deadline for payment of the first **50% of the contracted space**, discounting the space reservation fee.

May 8, 2026: deadline for payment of **100% of the contracted space and services**.

PAYMENT METHODS

Payment can be made in the following ways:

❖ Transfer to: IFEMA MADRID / SRR 2026

Santander: IBAN ES64 0049 2222 5115 1000 1900 SWIFT: BSCHEM

BBVA: IBAN ES89 0182 2370 4000 1429 1351 SWIFT: BBVAESM

Caixa Bank: IBAN ES93 2100 2220 1102 0020 2452 SWIFT: CAIXESBBXXX

Send a copy of the bank receipt to servifema@ifema.es

❖ Certified check, made out to IFEMA MADRID/ 2026

❖ Credit card in a secure environment, accessible at the end of the online completion of the participation application form, or later through Zona Expo. In accordance with current regulations, payments in cash or bearer checks are not accepted.

In the Expo Zone you will find your statement of accounts for participation in the fair and invoices, once payments have been made. If you need an invoice to make a payment, please request it by mail to atencionalcliente@ifema.es.

Discounts:

2.5% early payment discount on the floor fee, provided 100% payment is made, prior to February 8, 2026.

5% DISCOUNT ON SERVICES CONTRACTED THROUGH THE EXPO AREA, UP TO 30 DAYS BEFORE THE START OF THE ASSEMBLY.

This discount will also be applicable to services contracted by sending the plan of your stand to the technical secretariat. Mandatory minimum services are not included: outdoor advertising, meeting rooms, graphic decoration of stands or specific services of the fair such as exhibitor passes, invitations...

Surcharges:

25% increase for the hiring of services, including assembly rights, requested 7 days before the start of the assembly.

(1) Companies established in Spanish territory (excluding the Canary Islands, Ceuta and Melilla): 10% VAT not included. For all other companies this operation is not subject to Spanish VAT. In the case of companies from the European Union, the exhibitor will be responsible for the VAT which, if applicable, is due in their country of establishment.

1.9 Specific rules of participation

The decision to accept the exhibitor will be at the discretion of IFEMA Madrid taking into account the purpose of the fair and the availability of space. The minimum surface area for contracting is 16 sq.m.

The management of the fair may alter the assigned spaces or make changes in the distribution of the pavilions for organizational reasons.

Without prejudice to the Management of the fair informing exhibitors in the event of relocation or significant alteration of the reserved location, each exhibitor is obliged to inform himself of the location of his stand, its exact dimensions, etc.

No exhibitor or visitor who cannot be accredited as belonging to the participating professional groups is allowed access, even if they have the corresponding pass or invitation.

The exhibitor is obliged to attend his stand and remain with the products exhibited during the entire period and opening hours of the event. Failure to comply with these regulations could mean the loss of the right to preferential renewal of the space allocated.

The direct sale of any type of articles exhibited at the fair is strictly forbidden.

The exhibitor authorizes IFEMA MADRID the possible total or partial reproduction of the products exhibited in its promotional material.

The exhibitor agrees to respect the rules and guidelines for the protection of the environment.

Activities that may disturb other exhibitors are prohibited and may not exceed 60 decibels.

Promotional activities, distribution and exhibition of samples, brochures, leaflets, flyers and all kinds of promotional material shall be carried out only within the space of each exhibitor.

Activities requiring the contracting of a catering service during the fair will require the completion of the "Communication form for catering at stands" available at ifema.es and which should be sent to: catering@ifema.es

The installation by exhibitors of WIFI access points, either for INTERNET connection or for the presentation of other functionalities, is expressly forbidden. The purpose of this measure is to avoid interference problems, both with the points that may be installed independently by each Exhibitor, as well as the access points of IFEMA MADRID.

Such interference could cause the WIFI networks present not to work. For further information, please refer to Article 33 of the General Regulations for Exhibitor Participation in Exhibitions Organized by IFEMA MADRID.

CANCELATION

The Exhibitor's withdrawal from participation in the Show shall be grounds for termination of the contractual relationship between IFEMA MADRID and the Exhibitor for all purposes. The resignation must be communicated to the Show Management in writing addressed to the same and will entail the loss of the amounts that the exhibitor should have paid at the date of communication, according to the schedule of payment deadlines reflected in the Application for Participation.

If the cancellation has been communicated to the Show Management within thirty days prior to the opening of the event, IFEMA MADRID may require the exhibitor to pay the full amount of the contracted space.

In relation to the additional services offered by IFEMA MADRID that the exhibitor had contracted prior to the communication of the cancellation, the cancellation charges established in article 7 of the **general conditions of admission** and contracting in events organized by IFEMA MADRID shall apply.

In the event of cancellation of the fair due to force majeure, the amounts paid for concepts related to on-site participation will be refunded, according to article 15 of the **General Rules of Participation in events organized by IFEMA MADRID**.

1. HOW TO PARTICIPATE. REGULATIONS

1.10. Calendar

When	What	How	Who's attends you
From July 2025	Application for participation	- Receipt of requests for participation.	Contest management: @ifema.es Customer Service (Exhibitors): (+34)917223000 atencionalcliente@ifema.es
Until February 8, 2026 Until May 8, 2026	Payment	- Until February 8, 2026: 50% of the amount of the space discounting the reservation fee paid. - Until May 8, 2026: 100% of the amount of the space and services contracted.	Customer Service (Exhibitors)(+34)917223000 atencionalcliente@ifema.es
Until May 4, 2026	Free design projects	Deadline for uploading free design projects to the EXPO ZONE. If the project includes hanging elements, you must submit a separate project and send it to rigging@ifema.es .	Technical Secretariat IFEMA MADRID Line Exhibitors (+34) 917223000 atencionalcliente@ifema.es
Until May 4, 2026	Contracting of services	Services contracted with a 5% discount.	IFEMA MADRID Line Exhibitors (+34) 917223000 atencionalcliente@ifema.es
Until May 20, 2026	Customization of modular stands	- Submit projects for interior decoration of modular stands. - - Choose carpet color at ZONA EXPO before May 20, 2026. - - Communicate the signage in ZONA EXPO before May 20, 2026. - - The modular booth project must be consulted at ZONA EXPO, or upload the same with the stipulated modifications.	Technical Secretariat IFEMA MADRID Line Exhibitors (+34) 917223000 atencionalcliente@ifema.es

1. HOW TO PARTICIPATE. REGULATIONS

1.10. Calendar

When	What	How	Who's attends you
As of May 27, 2026	Contracting of services	25% increase on prices for last minute contracting of assembly rights and all other services.	IFEMA MADRID Line Exhibitors (+34)917223000 atencionalcliente@ifema.es
June 4 to 6, 2026	Stand assembly	<ul style="list-style-type: none"> - From June 4 to June 5 from 8.30 am to 9.30 pm - Saturday 6 will be from 8.30 am to 7.30 pm. 	-
June 7 and 8, 2026	Delivery of modular stands	Starting at 8.30 am.	Hall manager
	Goods receipt	<ul style="list-style-type: none"> - From 8:30 am to 9:30 pm. - On the 8th from 7:00 p.m. onwards, entry will only be possible through the pedestrian doors, closing the goods gates to proceed with the installation of recyclable carpeting in the aisles. 	Hall manager
June 9 to 11, 2026	Celebration of the fair	10 am to 7 pm on June 11 until 3 pm	-
June 11, 2026	Goods issue	From 3.30 pm to 9.30 pm. From 3.30 pm to 4.30 pm, exit will only be possible through the pedestrian gates to proceed with the removal of recyclable carpet. After this time, the merchandise gates will be opened until 9.30pm.	Hall manager
June 12 and 13, 2026	Dismantling of stands	Hours: June 12 from 8:30 a.m. to 9.30 p.m. and June 13 from 8.30 a.m. to 7.30 p.m.	Hall manager

2.1. Expo Zone. Manage your participation and your space. Contracting additional services. E-commerce

Access our customer area Expo Zone from the web: www.ifema.es/en/srr to manage your company data, your contacts and everything related to your participation. You will be able to access your participation once you have confirmed your participation with your user name (the e-mail address you used to fill in the application form).

What can I do from Zona Expo?

- Access the details of each participation, plans and projects
- Access the exhibitor's calendar.
- View documents of interest.
- Manage exhibitor passes and request visa support letters.
- Download discount vouchers: Renfe, Iberia, .
- Send invitations.
- Register co-exhibitors.
- Access orders, payments, account status and invoices issued.
- Upload free design stand projects.
- Request the distribution of elements of modular stands, coat racks or shelves, add the sign and choose the color of the carpet.
- Access to e-commerce for the contracting of services.

2.2. Registration of COEXPOSITORS

The registration of co-exhibitors must be done by the exhibitor from the EXPO ZONE, section "Manage your participation/Attach co-exhibitors".



To register, it is essential to enter a correct and unique e-mail address for each co-exhibitor and indicate whether the participation fee (EXHIBITOR CONECTA PLAN) will be paid by the exhibitor or by the co-exhibitor.

The condition of co-exhibitor implies the obligatory contracting of the elements included in the CONECTA EXHIBITOR PLAN (Marketing and Communication Pack + Liveconnect):

Registration fee per co-exhibitor 320.00 + VAT (1)

(1) Companies established in Spanish territory (excluding the Canary Islands, Ceuta and Melilla): 10% VAT not included. For all other companies this operation is not subject to Spanish VAT. In the case of companies from the European Union, the exhibitor will be responsible for the VAT which, if applicable, is due in their country of establishment.

Once this process has been completed, the co-exhibitor will receive a unique code to be included in his participation application*.

***If the exhibitor assumes the cost of participation of the co-exhibitor, its registration will be confirmed with the sending of the participation application (essential requirement).**

***If the co-exhibiting company assumes the cost of its participation, its registration will be confirmed with the sending of the participation application and the payment of the corresponding amount.**

Each registered co-exhibitor will have at its disposal the elements included in the CONECTA COEXHIBITOR PLAN:

- Access to SRR LIVEConnect.
- Presence in the online exhibitors' catalog.
- Visibility in the official list of exhibitors available at ifema.es/srr
- Access to your own EXPO ZONE.2 Exhibitor Passes.Online invitations.

2. MANAGE YOUR PARTICIPATION

2.3. Exhibitor/co-exhibitor passes, transport discount vouchers, visas and invitations

EXHIBITOR PASSES

Exhibitor passes will be managed from the EXPO ZONE, in the section "Access to the event/Exhibitor passes".

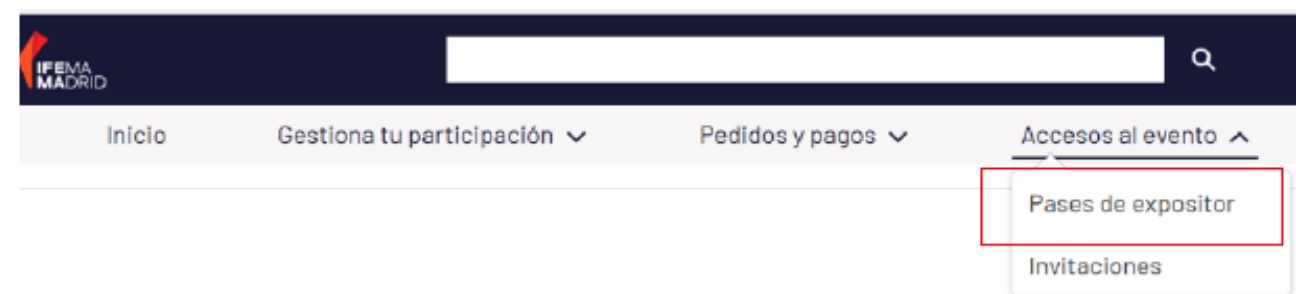

Each exhibitor will be assigned the passes that correspond to the contracted area (10 passes for stands up to 50.00 sq.m . 25 passes for stands from 50.5 to 150 sq.m. 40 passes for stands over 150 sq.m.

In order to ensure professionalism at the fair, all exhibitor passes will be personalized: they will include the name of the pass holder, company and country. In order to avoid misuse, identity checks may be carried out at the entrances to the fair.

Exhibitors may purchase additional exhibitor passes (€6/each +VAT) through ZONA EXPO.

COEXHIBITOR PASSES

The co-exhibitor must manage their **2 exhibitor passes** and their invitations online from **ZONA EXPO**.

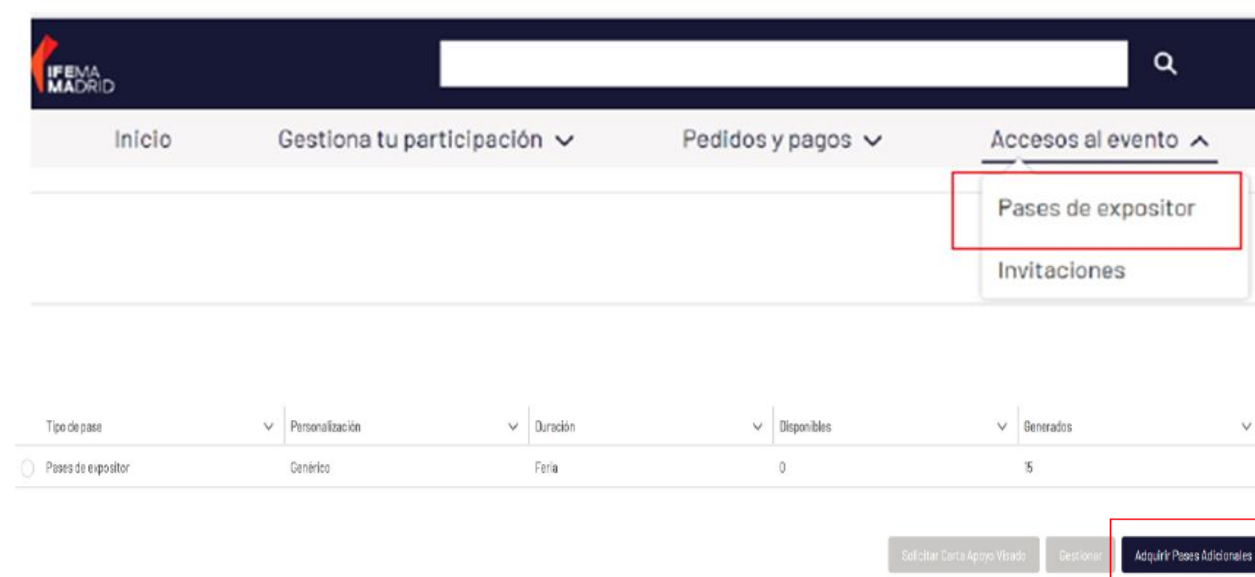
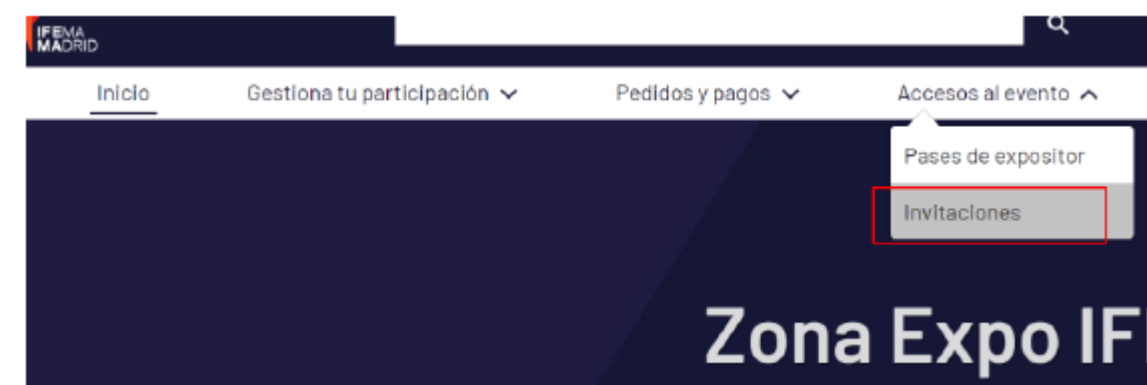

2. MANAGE YOUR PARTICIPATION

ONLINE INVITATIONS

Each exhibitor will be provided with professional online invitations to send to their contacts.

If additional invitations are required, please send an email to: srr@ifema.es, indicating the exact number of invitations.

Online registration will be open until June 11, 2026.

Invitations will be sent through "EXPO ZONE/Access to the event/Invitations/Manage invitations".

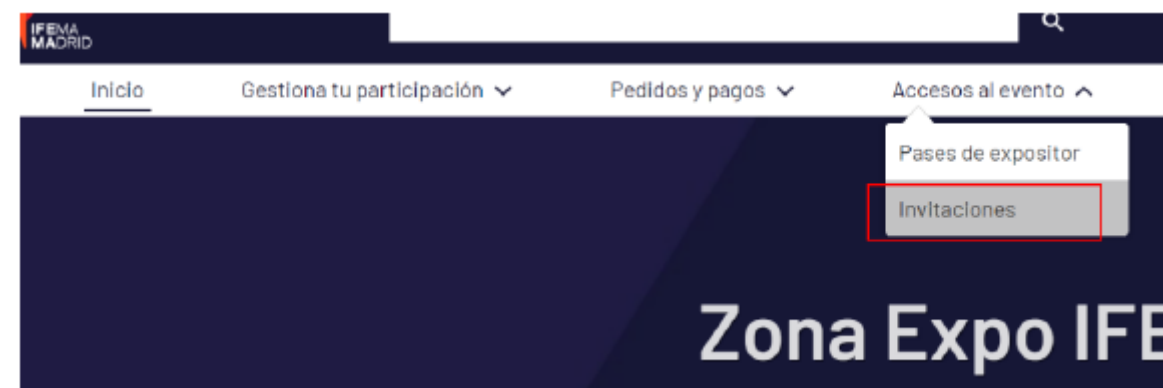

We appeal to exhibitors to make good use of the invitations, sending them exclusively to professionals of the sector to guarantee the professionalism of the fair. Access controls may be carried out for this purpose. Professionals who receive the invitation code must register ONLINE through the SRR website, in the section "Purchase your pass" and enter the invitation code received to obtain their free pass to access the fair. (Invitation codes cannot be redeemed at the counter). It will be absolutely necessary for all Professional Visitors who are going to access the venue with a Professional Invitation, to be accredited as Professionals, through ifema.es/SRR.

VISA MANAGEMENT

If you require a visa to travel, you can request from ZONA EXPO, the letters of support to manage it. To do so, you must first personalize your exhibitor's pass and have formalized the payment of your participation following the payment schedule (see point 1.8).

Once these two requirements are fulfilled, from "EXPO ZONE/Event Access/Exhibitor Passes" you will have access to the "Request visa support letter" button.

We advise you to start the process as soon as possible, since the deadline for visa application is usually at least 30 days before traveling.

TRANSPORT DISCOUNT VOUCHERS

Once the exhibitor passes have been requested, **the corresponding transport discount vouchers can be downloaded from ZONA EXPO**, in the section "Manage your participation/Documents".

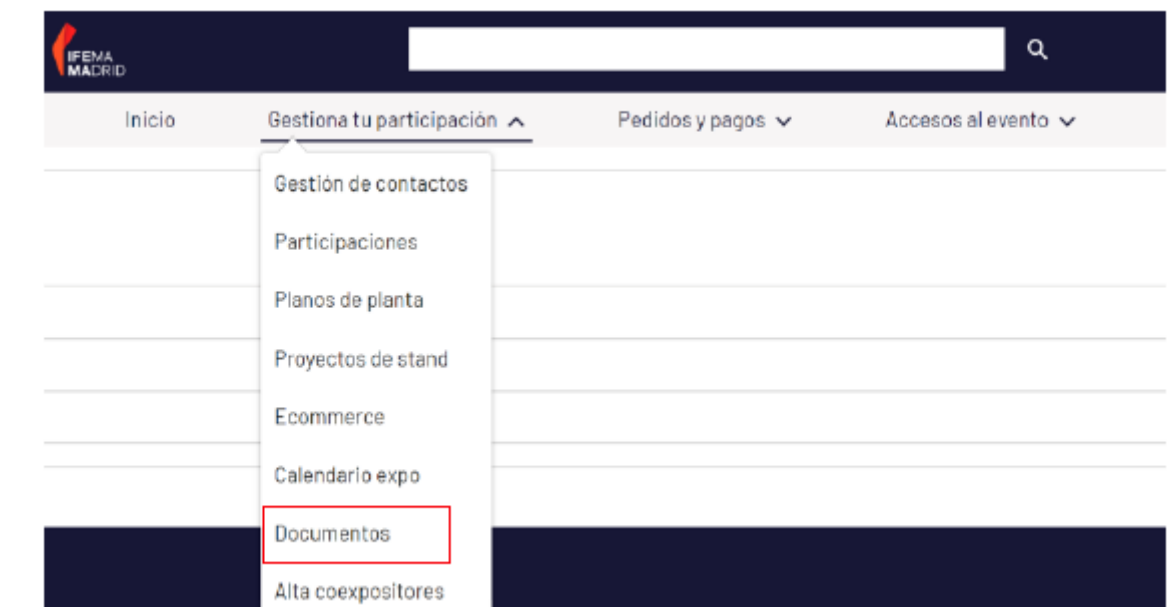

The following screen will then appear to customize the shipment:

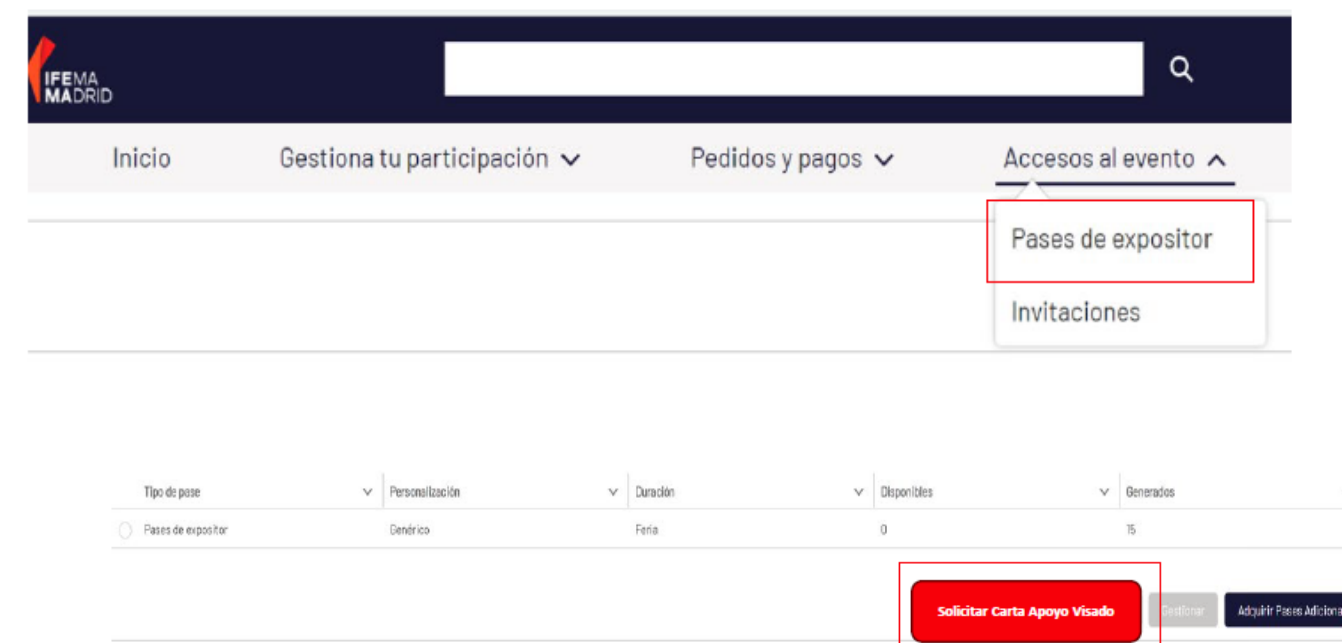

2.4 Other relevant information

Shipment of goods to the premises. Customs regulations.

IFEMA MADRID personnel are not authorized to receive any goods destined for your stand. In order to send goods to the venue, the exhibitor must indicate in the delivery address:

- ♦ IFEMA MADRID (Avda. del Partenón, 5. 28042 Madrid. Spain)
- ♦ Feria SRR
- ♦ Name of your company.
- ♦ Pavilion and stand number.

The goods must be received by your company's personnel at your stand and arrive during the days destined for the entry of goods and decoration.

In case it is not possible to comply with the above, we recommend you to contact our partner company for goods management (handling and warehousing):

DB Schenker office at IFEMA MADRID: Pavilion 7

Telephone: +34 91 330 51 77

ifema.madrid@dbschenker.com

CUSTOMS REGULATIONS

1. All products coming from non-EU countries must go through customs procedures, with special mention to the fact that since January 1, 2020, the United Kingdom has been treated as a third country, so all shipments originating in the United Kingdom must regularize their merchandise through the corresponding customs procedure.
2. Exhibiting companies must have the details of the customs agent who carries out the clearance of their goods or, failing that, a copy of the customs documentation of entry into the European Union.
3. The material or merchandise for distribution or consumption must pay Spanish taxes, even if they are products with no commercial value (depending on the country, the amount of taxes may vary).
4. All goods subject to a temporary regime must not be moved from the stand or leave the IFEMA MADRID Exhibition Center until their situation has changed and customs formalities have been completed. It may only be deposited during these procedures in the warehouse of the official logistics agent within the Fairgrounds.
5. It is strictly forbidden to exhibit, sell, consume or distribute non-Community merchandise at a fair before the customs procedures have been completed. This includes promotional material.

6. Products that are transported as hand luggage must be declared at Barajas Airport in the RED CHANNEL ("Something to declare") and must regularize the merchandise with the corresponding authority at the airport.

7. Goods that have not passed customs control and are on display will be confiscated by the customs authorities operating at the Fairgrounds until the appropriate documents are presented.

8. All trucks arriving at IFEMA MADRID under a transit consigned to IFEMA MADRID, must go to the warehouse of the official Logistics Operator, for the regularization of the goods transported, located at:

Avenida Partenón s/n

Entrada Oeste - acceso calle Ribera del Sena

Pabellón de servicios nave 2

28042 Madrid

In order to avoid unwanted situations, and for any doubt that may arise, you can contact our Customs Logistics Operator, DB SCHENKER: (+34) 91 330 51 77; email:

ifema.madrid@dbschenker.com

2. MANAGE YOUR PARTICIPATION

SRR

2.5. Plan



2.6. FREQUENT QUESTIONS

Ask	Reply
<p>REGULATIONS Where can I consult the IFEMA MADRID General Rules of Participation to which my participation is subject?</p>	<p>In addition to the Exhibitor's Guide, your participation in SRR is subject to the IFEMA MADRID General Rules of Participation, about which you should be informed and which you can access from the IFEMA MADRID website (www.ifema.es) and from the following link IFEMA MADRID General Rules of Participation.</p>
<p>REGULATIONS Can I hold raffles and drawings at the stand?</p>	<p>Raffles, and random combinations constitute gambling modalities provided for in articles 3.2 and defined in article 15 of Law 6/2001 of July 3, 2001 on gambling in the Community of Madrid. You have all the information in the following form https://sede.comunidad.madrid/comunicaciones-declaraciones/cifras-tombolas</p>
<p>REGULATIONS Is it mandatory to attend the stand at all times?</p>	<p>Yes, the exhibitor is obliged to attend its stand and remain with the products exhibited during the entire period and opening hours of the event, especially on the last day, Saturday, September 13, 2025, until 7.00pm Failure to comply with these regulations could mean the loss of the right to preferential renewal of the space allocated.</p>
<p>REGULATIONS Regulations and support for assemblers at the fairgrounds</p>	<p>https://www.ifema.es/en/support/exhibitors-ifema-fairgrounds</p>
<p>PARTICIPATION MODALITIES What is the difference between the floor only option and the turnkey modular stand option?</p>	<p>The floor-only modality includes only the contracting of the space and the compulsory elements (insurance, minimum electricity consumption and the CONECTA EXHIBITOR PLAN), and it is the exhibitor who has to create a free-design stand or contract it through the stand design service offered by IFEMA MADRID. Modular stands are delivered assembled. See description in section 1.5.</p>

2.6. FREQUENT QUESTIONS

Ask	Reply
<p>MERCHANDISE</p> <p>Can I send merchandise to my stand?</p>	<p>IFEMA MADRID staff is not authorized to receive goods from your stand. To send goods to the venue, the exhibitor must indicate in the delivery address: IFEMA MADRID (Avda. del Partenón, 5. 28042 Madrid. Spain). SRR Fair. Name of your company. Pavilion and stand number.</p> <p>The merchandise must be received by your company's personnel at your stand and arrive during the days set aside for the entry of merchandise and decoration. In case it is not possible to comply with the above, we recommend you contact the collaborating merchandise management company: DB Schenker Office at IFEMA Trade Fair Center MADRID: Hall 7, (+91) 330 51 77. ifema.madrid@dbschenker.com</p>
<p>ACCESS FOR ASSEMBLY AND DISASSEMBLY</p> <p>Can I access the site with vehicles for assembly and disassembly or loading and unloading of goods?</p>	<p>Access to IFEMA MADRID and inside the halls will be through the doors and on the days and times indicated in this Exhibitor's Guide. Access to the inside of the halls will be exclusively for unloading materials. Vehicles may not remain parked inside the halls or in adjacent areas.</p> <p>We remind you that, for occupational safety reasons, it is strictly forbidden to park in front of the goods entrance gates.</p> <p>IFEMA MADRID is not responsible for the surveillance of vehicles while at Feria de Madrid.</p> <p>There is a parking area for trucks and another for cars, which may be used by paying, if applicable, the corresponding fees. Consult rates. . Check rates</p>
<p>ASSEMBLY</p> <p>Are assembler's passes necessary during the assembly/disassembly of the fair?</p>	<p>No. The requirements to be allowed to ride are to pay 100% of your participation, to have presented and approved the project, to have paid the assembly fees, and to have completed the occupational risk protocol.</p>
<p>RIGGING</p> <p>What procedure do I have to follow to hang structures in the halls/rigging?</p>	<p>Exhibiting companies may hang elements from the roofs of the halls according to the procedure described in the "Regulations for hanging structures in Halls" and filling in the form "Application for authorization to hang structures/ Rigging" and send it to rigging@ifema.es</p>
<p>BILLING</p> <p>How can I request my invoices?</p>	<p>Invoices are not generated by default. You must request them directly to the IFEMA MADRID invoicing department (atencionalcliente@ifema.es) indicating the fair where you are exhibiting and the concepts to be included in the invoice. Once it has been generated, it will be available in your Expo Zone.</p>
<p>CONTRACTING SERVICES</p> <p>Where can I hire the services of my stand?</p>	<p>Accessing the E-commerce inside the Expo Zone or through the following link https://shop.ifema.es</p>

2.6. FREQUENT QUESTIONS

Ask	Reply
<p>EXPO ZONE How to use the EXPO ZONE?</p>	<p>The following video shows a tutorial on the use of the EXPO ZONE</p>
<p>EXPO ZONE What are the utilities of my Expo Zone?</p>	<p>It is used to manage the participation of each exhibiting company in SRR.</p> <ul style="list-style-type: none"> • Registration of contacts that will access the Expo Zone and management of access permissions. • Access to the exhibitor's calendar. • View documents of interest. • Manage exhibitor passes, request visa support letters and send invitations. • Access to payments, account status and invoices issued. • Upload free design stand projects and distribution of modular stand elements. • Add signage and choose carpet color for exhibitors with modular stands. • Access to e-commerce for the contracting of services.
<p>LIVE CONNECT What does the CONECTA PLAN include?</p>	<p>This concept of compulsory contracting includes the following services:</p> <ul style="list-style-type: none"> • Diffusion of participation in the fair through insertion in the list of exhibitors accessible in open access on the fair's website and shared in communications. • Presence during the celebration of the fair in the pavilion plans and exhibitors' lists. • Presence as exhibitors in the digital event of the fair SRR LIVE Connect with 10 products or services associated with the company file. • Access to IFEMA MADRID's "EXPO ZONE" customer portal to manage participation. • Exhibitor passes according to the contract (see point 2.2). • Online invitations according to the contract (see point 2.2) and delivery service through the EXPO ZONE as well as Club Cards and Buyers Program. • Discount vouchers on transportation. • Premium wifi connection for 3 users during the entire fair (5 GHz devices). Access codes will be sent the days prior to the start of the fair. • Access to SRR LIVE Connect for 3 users with connection functionalities to generate business opportunities.

2.6. FREQUENT QUESTIONS

Ask	Reply
<p>LIVE CONNECT</p> <p>What are the utilities of my LIVE Connect?</p>	<p>In my company's exhibitor area in LIVE Connect:</p> <ul style="list-style-type: none"> • Update the company data visible in the catalog and SRR LIVEConnect. • Display the offer of products and services. • Manage the company's appointment schedule for professional meetings at the stand. • Register other team members with access to LIVE Connect. <p>At the trade show in LIVE Connect:</p> <ul style="list-style-type: none"> • Complete my personal profile on the platform and my agenda of availability for meetings. • Search for contacts of interest in the professional network and request and agree to be a contact for chatting and videoconferencing. • Scan professional visitor passes at the fair. • View information about the offer of other exhibitors. • Consult the activities with the possibility of scheduling them and viewing the digital content available.
<p>CATERING</p> <p>Can I hire a catering service or serve my own food and beverages at the stand?</p>	<p>Yes, exhibitors who are going to offer, free of charge, a catering service at their stand, may do so either by submitting their request with the catering companies approved by IFEMA MADRID (Consult HERE the list) or through other catering service providers. In this case, it is essential to fill in the form "Notification for the provision of catering services on stands" available in the exhibitors' area of the institutional website and send it, with the information requested therein, to catering@ifema.es for its knowledge and appropriate effects.</p> <p>In case of failure to make the above-mentioned communication to IFEMA MADRID, the Exhibitor will not be able to offer this service in its stand.</p> <p>The Exhibitor assumes liability to third parties for claims arising from the aforementioned catering service, exonerating IFEMA MADRID from any liability in this regard.</p>
<p>AFTERWORK PARTY</p> <p>Can I extend the exhibition day by having a fun after-work party at my stand after the closing of the fair?</p>	<p>The celebration of a recreational afterwork outside exhibition hours is subject to prior authorization. They can only be held at the close of the fair (7pm) until 9pm.</p> <p>It is essential to send the authorization request to srr@ifema.es</p>

2.6. FREQUENT QUESTIONS

Ask	Reply
<p>STAND DECORATION Can I decorate and/or set up my stand with IFEMA?</p>	<p>Yes, IFEMA MADRID offers two main services:</p> <p><u>Graphic decoration for stands</u>: Customize your modular stand with the image of your brand generating maximum impact on visitors. There is a wide range of versatile graphic materials adaptable to walls, furniture, fronts, banners, etc. You can request information and a quote at decoraciongrafica@ifema.es. For premium stands contact with standspremium@ifema.es</p> <p><u>Stand design</u>: consists of an integral service of stand design totally adapted to your needs. From the planning of your space, design, assembly and disassembly. You can request information and budget at standbuilding@ifema.es</p>
<p>VISAS How do I request the visa support invitation letter?</p>	<p>Visa support letters are handled through the Expo Zone. To do so, you must first customize your exhibitor passes. Once the exhibitor passes have been processed, you will be able to request the invitation letters and download them to your computer.</p> <p>In order to be able to request the letters, you must be up to date with your payments according to the payment schedule.</p>
<p>COMPULSORY INSURANCE What coverage do I have as an exhibitor with the insurance included?</p>	<p>You can consult the coverage of the compulsory insurance policies in the IFEMA MADRID exhibitor support area.</p>
<p>WIFI How do I access the WIFI network as an exhibitor?</p>	<p>As an exhibitor you will receive as part of the CONECTA PLAN wifi connection for 3 users during the entire fair for exclusive use by stand holders. It is essential that the devices that allow connection in the 5 GHz band. Access keys will be sent the days before the start of the fair. You can contract additional wifi access from the e-commerce located within the Expo Zone or through the link https://shop.ifema.es</p>
<p>PARKING How to hire parking at IFEMA?</p>	<p>Exhibiting companies may contract parking spaces from e-commerce located within the Expo Zone or through the link https://shop.ifema.es</p> <p>Once the contract has been made, parking badges can be picked up from September 4 (first day of assembly) at the exhibitor service desk, located in the central boulevard between pavilions 6 and 8.</p>

3. PROMOTE AND MONETIZE YOUR PARTICIPATION

SRR

3.1 Exhibitors' Catalog.

The trade show catalog, or list of exhibiting and co-exhibiting companies, is an indispensable promotional and networking tool. It provides visitors and other exhibiting companies with basic information to prepare for the fair and makes it easier for them to find and contact you before, during and after the event.

- Enter and update your contact details, the products or services presented and the information you consider relevant to give the highest visibility to your company and get the highest return on your participation.
- The entire environment and digital communication of your participation is channeled through Liveconnect.
- Take full advantage of the platform offered by IFEMA to communicate your participation, schedule appointments, showcase your products and contact your target audience.
- Catalog advertising

3.2. Networking

Enrich your networking agenda.

Liveconnect gives you the opportunity to search for contacts among its participants. You can use filters by country, activity, position, products of interest, etc., to perform searches. Once you have located potential customers, you can ask them to contact you (by sharing information such as email and phone number). Once they have accepted you, you can chat with them or invite them to a face-to-face meeting at a trade show or by videoconference at the Liveconnect event.

Be proactive and take advantage of the opportunity to build a good contact list.

Other users will be able to request meetings by addressing their request either to the company in general (without prior acceptance of the contact) or to a particular team member (prior contact). In this way, the whole team will be able to schedule their schedule of appointments at the fair well in advance.

3.3. Invitations for your clients and contacts

IFEMA provides you with invitations to the fair to promote your participation efficiently. Be sure to use this useful tool that we make available to you in your Expo Zone.

3.4. Publish your news and novelties. RRSS and WEB

Promote your products, services and news for free through the SRR News newsletter that is sent periodically to a large database of professionals in the international sector. In addition, we disseminate these news on the website and social networks of the fair.

We also disseminate, via Social Networks, your "star products": Facebook, Twitter, LinkedIn and Instagram.

3.5. Publicidad exterior y digital

Outdoor and digital advertising projects tailored to your needs

- Promote your brand before, during and after the event.
- Attract new customers through the best B2B targeting in the market.

[More information here: Advertising | IFEMA MADRID](#)

See also the advertising options offered by the Liveconnect platform.

3.6 Room Rental

For the exhibitors of the event, there is the possibility of renting rooms at the venue if you wish to prepare a conference, reception, press conference or product presentation during the fair. It is necessary to make a reservation in advance.

Request a quote: (+34) 91 722 30 00
uanproduccion@ifema.es

[MORE INFORMACIÓN](#)

4. SUSTAINABILITY MANAGEMENT AT IFEMA MADRID

SRR

At IFEMA MADRID we are not only fully committed to sustainability per se, but also, to achieving the sustainable development goals (hereinafter SDGs) promoted by the United Nations, which we have incorporated into our strategic corporate management policy and culture.

IFEMA MADRID's sustainability policy is mainly focused on the following SDGs: 8, 9, 11, 12, 13, 16 and 17.

ISO Standards certified by IFEMA MADRID:

- ISO 9001: Quality Management,
- ISO 20121: Event Sustainability Management.
- ISO 14001: Environmental Management,
- ISO 50001: Energy Management,
- ISO 22320: Emergencies Management..

ACTIONS TAKEN AT IFEMA MADRID TO REDUCE GAS EMISSIONS AND BE MORE ENERGY EFFICIENT:

- 100% certified electrical energy of renewable origin.
- Geothermal installation in Puerta Sur building.
- Low consumption lighting in our halls and on our modular stands.
- Controlling the temperature of our air-conditioning / HVAC systems.

IFEMA MADRID is in possession of "calculo" (I calculate) and "reduzco" (I reduce) stamps in Carbon Footprint Scopes 1 and 2.

WASTE MANAGEMENT:

- The exhibitor/assembler is the generator of the waste and shall therefore be responsible for its removal and management. How the waste generated by the exhibitor is managed is explained in article 35 of the General Rules of Participation.
- We offer our exhibitors a service that includes the removal and management of the waste they/their assemblers generate.

CARPET RECYCLING:

IFEMA MADRID recycles 100% of the carpet used in corridors and common areas. To do this, it is essential to start removing it before dismantling begins, which implies a distribution by strips, instead of covering the entire space as before.

In this way, we can guarantee its transformation into new raw material for the subsequent manufacture of other products.

SUSTAINABLE MOBILITY:

IFEMA MADRID offers access to public transport close to its facilities (metro and bus), parking for electric cars with 100% renewable electricity charge points, as well as a parking area for bicycles and scooters.

GUIDE TO SUSTAINABLE PARTICIPATION IN TRADE FAIRS/EVENTS:

IFEMA MADRID has published its Guide to Sustainable Participation in Trade Fairs for exhibitors on its website. We recommend you read it before starting to prepare your participation: ifema.es/en/about-us/quality-sustainability



5. Contact with us

Department	Ask about	Contact		
Address of the contest	<ul style="list-style-type: none"> • Space contracting • General topics of participation in the fair • Exhibitor passes • Professional visitor invitations • Activities and forums at the fair 	Director	David Moneo	(+34)91 7223000 srr@ifema.es
		Commercial Manager	Javier Sanz de Andino	
		Comercial area	Susana Martínez Aguirre	
IFEMA MADRID Customer Service	<ul style="list-style-type: none"> • Hiring of services • Expo Zone • Visitor information 	(+34)91 722 30 00 atencionalcliente@ifema.es		
Technical Secretariat(Directorate of Trade Fair Services)	<ul style="list-style-type: none"> • Technical support to exhibitors and assemblers. • Review of stand assembly projects. • Solutions to technical problems during the fair activity • Customization of modular stands • Coordination for stand catering. 	(+34)91 722 30 00 stecnica@ifema.es catering@ifema.es		
Graphic decoration	Hiring of graphic materials to customize your booth	(+34)91 722 30 00 decoraciongrafica@ifema.es standspremium@ifema.es		
Full service stand design	Design and assembly of free design stands	(+34)91 722 30 00 standbuilding@ifema.es		

Departament	Ask about	Contact
Outdoor Advertising	Hiring of advertising media at the fairgrounds	(+34) 91 722 53 40/08 publicidadexterior@ifema.es
Communication and Marketing Management	Media relations	<div style="display: flex; justify-content: space-between;"> <div> <p>Director: Raúl Diez Director of Comunication: Nuria de Miguel Press officer: Jesús González International press: Elena Valera Press secretariat: Gema Ramírez</p> </div> <div> <p>(+34) 91 722 50 93 jesusg@ifema.es</p> </div> </div>
Directorate of Planning and Control	<ul style="list-style-type: none"> Rental of the different meeting and convention spaces at the fairgrounds, both during and outside the fairs. Coordination of extra-fair activities 	(+34) 91 722 30 00 uanproduccion@ifema.es
Institutional Relations (Protocol)	<ul style="list-style-type: none"> Institutional visits Guided tours Protocol for all events Institutional relations 	(+34) 91 722 30 00 infoifema@ifema.es
Autoprotection and Security Direction	<ul style="list-style-type: none"> General security and parking Fairground accesses 	(+34) 91 722 50 65 dseguridad@ifema.es
Medical Service and Security Emergencies	<ul style="list-style-type: none"> Medical emergency Health care for exhibitors and visitors during fairs, set-up and dismantling. 	(+34) 91 722 54 00 Space located on the second floor between pavilions 7 and 9.

Thanks

