



SEMANA INTERNACIONAL
DE LA ELECTRIFICACIÓN
Y LA DESCARBONIZACIÓN

24-26
Nov
2026

ifema.es

Exhibitor's Guide
and Specific Rules
of Participation



INDEX

1. HOW TO PARTICIPATE

- 1.1 Dates, schedule, and venue. Invited sectors
- 1.2 What do I need to do to participate?
- 1.3 Space allocation and contracting
- 1.4 Participation options
- 1.5. Liveconnect: the digital platform accessible with your exhibitor plan
- 1.6. Your space at the fair. Stand types
- 1.7 Participation fees
- 1.8 Deadlines and payment methods
- 1.9 Specific fair regulations
- 1.10 Exhibitor calendar

2. MANAGE YOUR PARTICIPATION

- 2.1 Expo Zone. Manage your participation and space. Additional services contracting. E-commerce
- 2.2 Registration of co-exhibitors
- 2.3 Exhibitor passes and invitations. Visas. Vouchers and discounts
- 2.4 Other relevant information
- 2.5 Map
- 2.6 FAQs

3. PROMOTE AND MAXIMIZE YOUR PARTICIPATION

- 3.1 Exhibitor Catalogue
- 3.2 Invitations for your clients and contacts
- 3.3 Networking
- 3.4 Outdoor advertising
- 3.5 Innovation Gallery

4. SUSTAINABILITY MANAGEMENT AT IFEMA MADRID

5. CONTACT US

1. HOW TO PARTICIPATE

1.1 Dates, Schedule, and Venue. Invited Sectors

MATELEC will take place at the **IFEMA MADRID exhibition centre from 24 to 26 November 2026** from **9:30 am to 6.30 pm**. Exhibitors will be able to enter the venue from **8.30 a.m and leave it before 7.30 p.m.**

The virtual event via the liveconnect platform will be open from 1st September to 2nd April 2027.

The character of the fair is 'professional'.

To apply to take part in the fair, it is a requirement that the activity of the company, public or private organisation, falls within the sectors covered by the fair: MATELEC 2026.

1.2 What do I have to do to participate?

The application to participate begins by completing, within the established deadline, the online Application to Participate form available on the fair's [website](#).

The submission of the Application to Participate implies full acceptance of the **General Rules of Participation in Exhibitions organised by IFEMA MADRID**, the technical annexes, the Specific Rules of this edition and any generic or specific provisions established by the fair organisers.

The exhibitor company is the company in whose name the application to participate as an exhibitor is completed.

In order to apply to participate in the fair, it is a requirement that the exhibitor's activity, whether it is a company, public or private organisation, is included within the sectors covered by the event.

By clicking on the send application button, the exhibitor confirms to IFEMA MADRID that he/she is seriously interested in participating as an exhibitor and in receiving a proposal.

The decision to accept the exhibitor shall be at the discretion of IFEMA MADRID, taking into account the purpose of the fair and the availability of space.

IFEMA MADRID will make one or more space/location proposals depending on the type of participation and/or type and size of stand requested. This proposal constitutes a contracting offer. If the contracting party accepts the offer/quote in writing/email/signature or during a meeting to choose spaces, the contract for participation in the fair will be formalised.

1.3 Space contracting and allocation.

FIRST ALLOCATION

If you wish to participate in **MATELEC 2026**, you must send the completed **Participation Application Form**.

The companies that submit this documentation **before 20 April 2026** will be able to participate in the **first allocation of spaces that will take place during the month of May 2026** in order to optimise the possibilities in the choice of space. We will provide information on the criteria for the selection of spaces that will be applied in this first awarding of spaces at a later date.

NEW REQUESTS FOR PARTICIPATION

Requests for space received after 20 April 2026 will be dealt with, in order of arrival of the 'Participation Application' (an essential requirement and which will determine the date of entry of the request for participation as an exhibitor), **from June 2026 onwards**.

Space will be allocated after written acceptance by the exhibitor.

The exhibitor will receive the exhibition contract with the statement of accounts and stand plan(s) and will then be able to access the **Expo Zone** customer portal to manage his participation.

It is essential to make the payments indicated in the contract within the established deadlines.

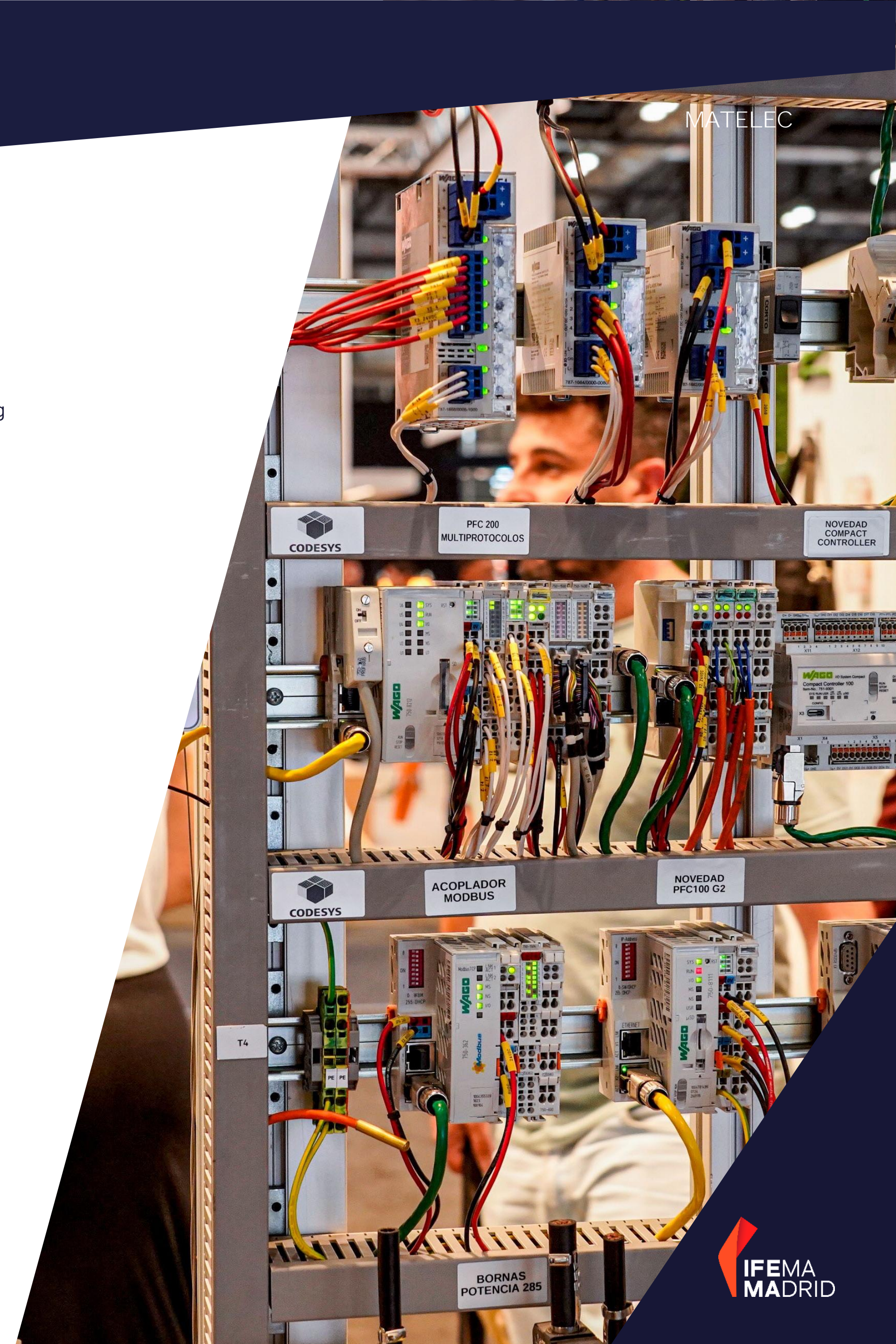

1.4 Participation Options.

- **Exhibitor:** is the natural or legal person, which has space at the the fair. The exhibiting company is the company in whose name the application to participate as an exhibitor is completed. The exhibitor has the option of contracting a 'basic turnkey stand' or contracting only the space to build his own 'free design stand'.
- **Co-exhibitor:** Participating in the stand of a main exhibitor by contracting directly with them.

1.5. Liveconnect: the digital platform you have access to with your Exhibitor Plan.

What will you find at liveconnect?

Liveconnect is a digital ecosystem that **fosters connections with other professionals**, facilitates meeting preparations, offers exclusive content and activities, and generates business opportunities.

- **Business and networking:** Identify leads to generate business and schedule high-value meetings.
- **Post-fair ecosystem:** Activity and visibility after the fair: access and share content, participate in challenges, and much more.
- **Positioning:** Highlight your company and increase the visibility of your offering.

What can I do from my Exhibitor Area in liveconnect?

- Update my company details visible in the web catalogue and in Semana de la Electrificación y Descarbonización liveconnect.
- Add my products and services, which will be visible in Semana de la Electrificación y Descarbonización liveconnect.
- Register team members so they can access the digital event Semana de la Electrificación y Descarbonización liveconnect.

What can I do during the digital event Semana Internacional de la Electrificación y de la Descarbonización liveconnect?

- Search for relevant contacts in the professional network
- Contact request for chatting and videoconference.
- Request and/or accept appointments for professional meetings at my stand at the fair or by videoconference.
- Complete my professional profile as a user of the platform and set my availability agenda of for meetings.
- Check out onsite and online activities and add them to your calendar.
- View information on what other exhibitors offer.
- Scan visitor passes at the fair.

CONECTA EXHIBITOR PLAN

Participation as an exhibitor or co-exhibitor at the fair requires contracting the **CONECTA EXHIBITOR PLAN (former Communication and Marketing Pack + liveconnect): 430€ + VAT (1)**

This concept includes the following services:

- Dissemination of participation in the fair through inclusion in the list of exhibitors accessible in open access on the website ifema.es/en/matelec and shared as a link in sectoral communications.
- Presence as exhibitors in the digital event of the **Semana Internacional de la Electrificación y de la Descarbonización liveconnect**. The digital event extends the duration of the fair beyond the event itself, provides additional content on the exhibition and sector news and is accessible to exhibitors and registered visitors.

- Presence during the fair on floor plans and exhibitor lists.
- Access to IFEMA Madrid's "**Expo Zone**" customer private area for managing participation.
- Exhibitor passes according to the contracted space (see point 2.3).
- Online invitations according to the contracted space (see point 2.3).
- Discount transport vouchers.
- Premium Wi-Fi connection for 3 users throughout the fair (these connections only work with devices compatible with the 5 GHz band). The password will be activated for the fair's duration and will be sent to the registered email address at least 48 hours before the event.

Functionalities for connecting with other users to generate business and networking opportunities:

- Search for new contacts among registered visitors and exhibitors.
- Communication with contacts (chat and videoconferencing).
- Preparation of meetings to optimise time at the trade fair.
- Scanning of visitor passes at trade fairs.

1. HOW TO PARTICIPATE

MATELEC

1.6 Your Space at the Fair. Stand Types

- **Basic Turnkey Stand and Startup Stand:** Modular stand, aluminum structure in grey, melamine panels.
- **Premium Design Stand:** Structure of modular aluminium frames connected internally at a height of 2.5 m with palboard walls.
- **Only Floor:** Only floor space. This option involves renting space only, and exhibitors must submit a stand construction Project for IFEMA MADRID's approval

Participating in the fair requires contracting the following general services:

- Liability insurance (coverage up to €60,000)(*) → 72,84€ + VAT (1)
- Multifair insurance (coverage up to €50,000)(*) → 69,15€ + VAT (1)
- Minimum energy consumption (0.13 kW/sq.m)(*) → 7,65€ + VAT (1)
- Assembly rights (service included with the Turnkey Stand)(*)
 - **Type A:** Undecorated spaces, or spaces covered with carpet or platform. → 2,77€/sq.m + VAT (1)
 - **Type B:** Basic aluminum modular stands or similar. → 5,56€/sq.m + VAT (1)
 - **Type C:** Custom-designed modular stands, carpentry stands, and other materials. → 8,85€/sq.m + VAT (1)
- Conecta Exhibitor Plan.

(*) Services already included with the Basic, Stratup and Premium Turnkey Stand.



BASIC TURNKEY STAND

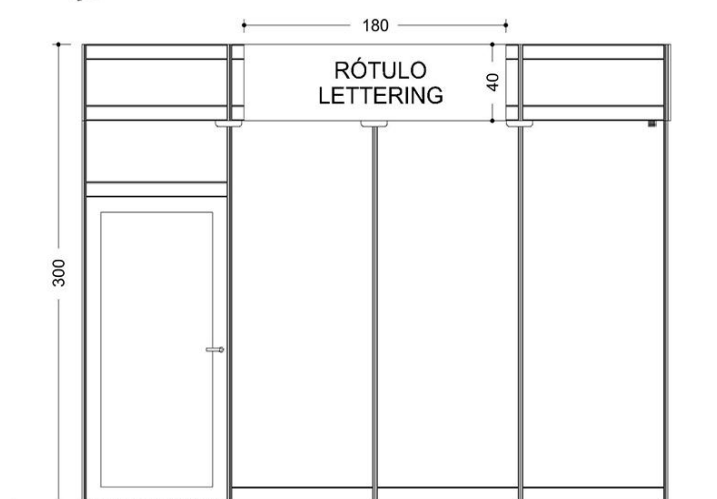

STAND

Stand open to one or more aisles depending on location.
Grey aluminium structure and melamine walls.

WAREHOUSE with lockable door in the following proportion:

Up to 16 m².....1x1 m
From 16,5 to 32 m²2x1 m
From 32,5 m².....3x1 m

TRADE FAIR CARPET

5 colours to choose from in the Expo Zone.
Exhibitors must indicate their chosen carpet colour by **November 3rd, 2026**.
If no colour is indicated, the default colour will be jasper grey.

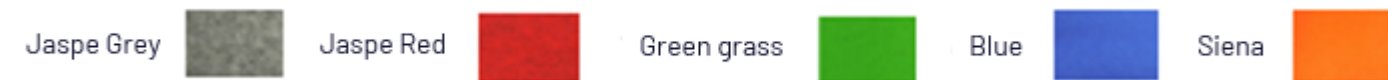

ELECTRICITY AND LIGHTING

- Lighting by means of LED spotlights on rails at a rate of one spotlight per 3 sq.m of stand.
- Electrical panel with magnetothermal differential with a built-in 500W socket, suitable for 130W/sq.m power.

SIGNAGE

Standard lettering with exhibitor's name, editable in **Expo Zone** and stand number. **Maximum 20 characters.**

If the exhibitor name field is not completed in the Expo Zone, it will be labelled with the Trade Fair Name on the Participation Application Form. The exhibitor must indicate the company name chosen for the sign before **November 3rd, 2026**.

FURNITURE

- White Dom Table (6RL02001)
- 3 Madrid Chairs (6RL01001)
- 1 Tana counter (6RL08003)
- 1 Palermo Stool (6RL01062)



MANDATORY CONTRACTING

In addition, participation as an exhibitor implies the obligatory contracting of the EXHIBITOR CONECTA PLAN (former Marketing and Communication pack): 430€ + VAT (1)

SERVICES INCLUDED

- Daily cleaning of the stand (Type A, once a day).
- Assembly fees included in the price.
- Multi-fair and civil liability insurance included in the price.
- Minimum electricity consumption (0.13 Kw /m²).
- 1 parking ticket.

CLEANING TYPE A:

First cleaning with removal of the plastic covering the carpet and daily cleaning of the floor and collection of the contents of the litter bins. Does not include the cleaning of the exhibits.

ASSEMBLY PLAN

Your assembly plan can be viewed in the **Expo Zone** with the location of the warehouse and other services included. You can also monitor the status of the plan and comment on it in case you need to make any changes.

ADDITIONAL SERVICES

Customise your modular stand with our Stand Graphic Decoration service decoraciongrafica@ifema.es

INDICATIVE DRAWING. Drilling and nailing are not permitted. Adhesive tape may be used, provided that its removal does not damage the panels. It must be adapted to the dimensions of the space allocated.

OBSERVATIONS: •Any services or modifications that may be introduced based on these characteristics shall be at the exhibitor's expense. •The elimination or substitution, by the exhibitor, of any formative element of the modular stand does not imply a reduction in the cost. • The distribution of all the elements that make up the stand, the extras requested, as well as the structural elements necessary for the support of the stand, shall be adapted to the needs of the exhibitor, provided that it is technically feasible and that the plan with the relevant indications is received fifteen days before the first day of the start of assembly. Once the stand has been assembled, any changes to the location of all the elements that have not been communicated on the established date will be invoiced. • All the material used, both structural and electrical, is for hire and any deterioration will be invoiced according to the current price list. •In addition, any exhibitor can hire elements listed in the IFEMA Services Catalogue.

STARTUP STAND



STAND

Stand open to one or more aisles depending on location. Grey aluminium structure and melamine walls.

6 m² (not extendable)..... 1.600€ + VAT (1)

TRADE FAIR CARPET

The default colour will be red.



ELECTRICITY AND LIGHTING

- Lighting by means of LED spotlights on rail at a rate of 1 spotlight every 3 m² of wall.
- Electrical panel with magneto-thermal differential, prepared for a power of 130 w/m², and a built-in 500w socket.

SIGNAGE

Standard lettering with name of exhibitor editable in Expo Zone and stand number. **Maximum 20 characters.**

If the exhibitor's name field is not completed in the **Expo Zone**, it will be labelled with the Trade Fair Name on the Participation Application Form. The exhibitor must indicate the company name chosen for the sign before **November 3rd, 2026**.

FURNITURE (*)

- 1 White Dom Table (6RL02001)
- 3 Madrid chairs (6RL01001)
- 1 counter Tana 100X50X100 cm (6RL08003)

*furniture described or similar



MANDATORY CONTRACTING

In addition, participation as an exhibitor implies the obligatory contracting of the EXHIBITOR CONECTA PLAN (former Marketing and Communication pack): 430€ + VAT (1)

SERVICES INCLUDED

- Daily cleaning of the stand (Type A, once a day).
- Assembly fees included in the price.
- Multi-fair and civil liability insurance included in the price.
- Minimum electricity consumption (0.13 Kw /m²).
- 1 parking ticket.

ASSEMBLY PLAN

Your assembly plan can be viewed in the Expo Zone with the location of the warehouse and other services included. You can also monitor the status of the plan and comment on it in case you need to make any changes.

ADDITIONAL SERVICES

Customise your modular stand with our Stand Graphic Decoration service decoraciongrafica@ifema.es

CONDITIONS FOR RECRUITMENT

- Recently created companies whose incorporation is between November 2020 and November 2026 may participate, as well as companies whose average number of employees during two consecutive financial years does not exceed 10. (It is compulsory to provide a commercial report from the Commercial Register and IAE).
- Distributors and Brand Licensing companies are not included in the above, and are therefore not allowed to participate as an Entrepreneurship company.
- Sharing space is not permitted.
- Each company must have its own independent Application and space. The permanence as a Start-up company is limited to two consecutive editions.
- Therefore, in the next edition/s, they will participate in the general exhibition.
- Spanish and foreign companies can participate.

INDICATIVE DRAWING. Drilling and nailing are not permitted. Adhesive tape may be used, provided that its removal does not damage the panels. It must be adapted to the dimensions of the space allocated.

OBSERVATIONS: •Any services or modifications that may be introduced based on these characteristics shall be at the exhibitor's expense. •The elimination or substitution, by the exhibitor, of any formative element of the modular stand does not imply a reduction in the cost. • The distribution of all the elements that make up the stand, the extras requested, as well as the structural elements necessary for the support of the stand, shall be adapted to the needs of the exhibitor, provided that it is technically feasible and that the plan with the relevant indications is received fifteen days before the first day of the start of assembly. Once the stand has been assembled, any changes to the location of all the elements that have not been communicated on the established date will be invoiced. • All the material used, both structural and electrical, is for hire and any deterioration will be invoiced according to the current price list. •In addition, any exhibitor can hire elements listed in the IFEMA Services Catalogue.

PREMIUM STAND

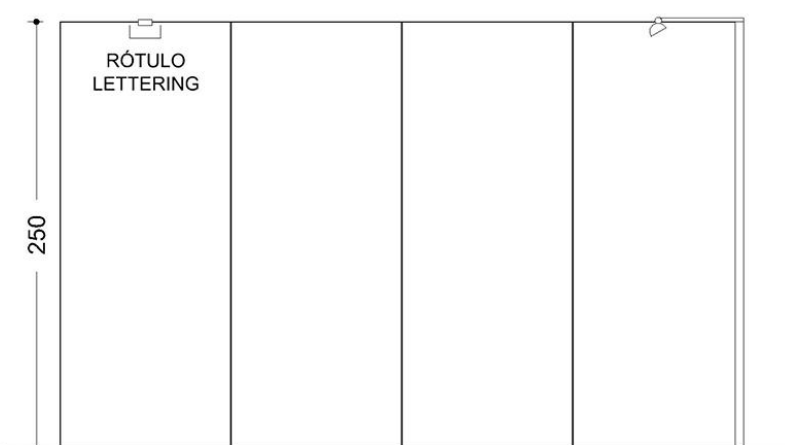

STAND

- **The minimum surface area for contracting is 16m².**
- Stand open to one or more aisles.
- Structure of modular aluminium frames connected internally at a height of 2.5 m with palboard walls (colour change will be charged as an extra charge, upon request for quotation).

WAREHOUSE with lockable door with code in the following proportion:

Up to 23.5 m²1x1 m
 From 24 to 31.5 m²2x1 m
 Over 32 m²3x1 m

TRADE FAIR CARPET

5 colours to choose from in the EXPO AREA. (Exhibitors must indicate the chosen carpet colour by **November 3rd, 2026**..

If no colour is indicated, jasper grey will be used by default).

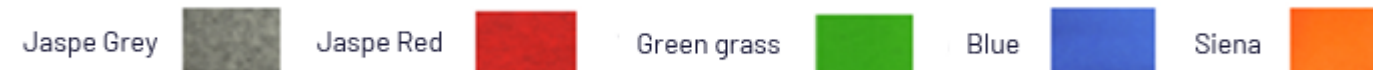

SIGNAGE

Standard lettering with exhibitor's name editable in **Expo Zone** and stand number. **Maximum 20 characters.**

If the exhibitor's name field is not completed in the Expo Zone, it will be labelled with the Trade Fair Name on the Participation Application Form. The exhibitor must indicate the company name chosen for the sign before **November 3rd, 2026**.

ELECTRICITY AND LIGHTING

- Electrical panel at a rate of 130wxm
- 21 led spotlight of 25w x each 4 sq.m
- Double socket base

MANDATORY CONTRACTING

In addition, participation as an exhibitor implies the obligatory contracting of the EXHIBITOR CONECTA PLAN (former Marketing and Communication pack): 430€ + VAT (1)

SERVICES INCLUDED

- Daily cleaning of the stand (Type A, once a day).
- Assembly fees included in the price.
- Multi-fair and civil liability insurance included in the price.
- Minimum electricity consumption (0.13 Kw /m²).

CLEANING TYPE A

First cleaning with removal of the plastic covering the carpet and daily cleaning of the floor and collection of the contents of the litter bins. It does not include the cleaning of the exhibits.

ASSEMBLY PLAN

Your assembly plan can be viewed in the **Expo Zone** with the location of the warehouse and other services included. You can also monitor the status of the plan and comment on it in case you need to make any changes.

ADDITIONAL SERVICES

Customise your stand by contacting standspremium@ifema.es

DRAWING FOR GUIDANCE ONLY. No drilling, nailing or gluing is permitted. It shall be adapted to the measurements of the space allocated.

REMARKS: - Any services or modifications that may be introduced based on these characteristics shall be at the exhibitor's expense. - The elimination or substitution, by the exhibitor, of any training element of the modular stand does not imply a reduction in the cost. - The distribution of all the elements that make up the stand, the extras requested, as well as the structural elements necessary for the support of the stand, shall be adapted to the needs of the exhibitor, provided that it is technically feasible and that the plan with the relevant indications is received fifteen days before the first day of the start of assembly. Once the stand has been assembled, any changes to the location of all the elements that have not been communicated on the established date will be invoiced. - All the material used, both structural and electrical, is rented and any deterioration will be invoiced according to the current rates. - In addition, any exhibitor can hire elements listed in the IFEMA Expo Zone Services Catalogue.

1. HOW TO PARTICIPATE

Turnkey stand regulations (Basic/StartUp/Premium)

All modular stands involving interior decoration with panels, profiles, totems, platforms, trusses, etc., are **REQUIRED to UPDATE their project in THEIR Expo Zone one month before the start of assembly (October 18th, 2026).**

The elimination or substitution, by the exhibitor, of any element of the modular stand does not imply a reduction in cost. All the material used, both structural and electrical, is rented and any deterioration will be invoiced according to current rates.

The distribution of all the elements that make up the stand, the requested extras, as well as the structural elements necessary for the support of the stand, will be adapted to the needs of the exhibitor, as long as it is technically feasible and the plan with the pertinent indications IS UPLOADED IN THE Expo Zone one month before the beginning of the assembly: October 18th, 2026.

CUSTOMIZE YOUR BOOTH WITH US: GRAPHIC DECORATION FOR BOOTHS

Customize your modular stand with your brand image to generate maximum impact on visitors. We offer you a wide range of graphic materials (vinyl, foa.m, Forex, tarpaulins...) versatile and adaptable to all the elements of your stand (walls, furniture, fronts, banners, displays...). Ask for more information and quotation. Our specialized team will follow up the production and installation. decoraciongrafica@ifema.es

Once the stand has been assembled, changes in location can be made



FREE DESIGN STANDS – FLOOR SPACE ONLY

RATES – Floor only:

- From 16 sq.m to 50 sq.m..... 175€ /sq.m
- From 50,50 sq.m to 100 sq.m.....170€/sq.m
- From 100,5 sq.m to 250 sq.m163€ /sq.m
- From 250,50 sq.m.....160€ /sq.m

OTHER RATES

- 2nd floor** Fee : 94 €/sq.m + VAT (1)
- Corridor** Fee:..... 116 €/sq.m + VAT (1)
- Outdoor Area** Fee :.....157€/sq.m + VAT (1)

Includes:

- Space rental.
- Professional invitations in electronic format.
- Exhibitor passes.

All Exhibitors who opt for construction under the **Floor Space Only** modality must upload the free design project, floor plan and front and side elevations to the Expo Area, to the Technical Secretariat of the Trade Fair Services Department of IFEMA MADRID sectecnica@ifema.es for approval, by **October 18, 2026**.

RIGHTS OF ASSEMBLY

The company responsible for assembling the free-design stands must pay IFEMA MADRID, before commencing such work, the corresponding assembly fees for the services provided during the assembly and dismantling period of the fair: healthcare service (ATS), inspection of electrical installations, connections and electricity supply during assembly and dismantling, use and maintenance of paint rooms, personalised service for the assembler and individualised signage for spaces.

REGULATIONS ON ASSEMBLY RIGHTS

Companies **that choose to build their own stands must upload the project to their Expo Zone** for approval before **October 18, 2026**.

In order to be more efficient and provide you with better service, avoiding incidents during set-up, from 18 October 2026 we will apply a last-minute surcharge to the contracting of set-up rights, as is the case with the rest of our services.

This surcharge **increases the price by 25%** when the contract is signed during the week prior (7 days prior, **November 11, 2026**) to the start of assembly, during assembly, celebration and dismantling.

Please note that assembly fees apply to free-design assemblies and can be contracted at a 5% discount if the contract is signed at least 30 days before the start of the exhibition assembly (**October 18, 2026**) To contract services, please visit our online channel, which you can access via the following link: [Expo Zone](#)

RATES ASSEMBLY FEES

- Spaces without decoration or occupied by carpet or wooden flooring – TYPE A** rate: 2,77 €/sq.m + VAT (1)
- Basic modular stands made of aluminium or similar material – Rate TYPE B:** 5,56 €/sq.m + VAT (1)
- Modular aluminium stands, wooden stands and other materials - Rate TYPE C :** 8,85 €/sq.m + VAT (1)

If, as a registered exhibitor, you wish to pay this fee and have it included in your invoice, you must arrange this in your [Expo Zone](#)

RATES FOR MANDATORY CONTRACTING SERVICES

Being an exhibitor entails taking out: Civil Liability Insurance (covering up to €60,000):..... €72.84 + VAT (1)
 Multi-fair insurance (covering up to €50,000):..... €69.15 + VAT (1)
 Minimum energy consumption (0.13 kW/sq.m):€7.65/sq.m + VAT (1)
 Conecta Exhibitor Plan:.....€400 + VAT (1)
 Set-up fees

ASSEMBLY RULES FOR FREELY DESIGNED STANDS

- All companies will be required to assemble their stand, which must include at least the walls separating it from the pavilion wall or other stands, and to submit their occupational risk protocol.**
- Companies that choose to build their own stands must send the project to the Technical Secretariat of IFEMA MADRID for approval before **October 18, 2026: sectecnica@ifema.es**

In the event that the project involves any elements suspended from the pavilion ceiling, please note that it is mandatory to contract the suspension points with the fair (see online rates in the exhibitor area) and to submit an exclusive rigging project **before 18 October 2026**.
You must complete the following form: [Application for hanging structures / rigging | IFEMA MADRID](#) and send the project to: rigging@ifema.es

The DR or Visa Certificate must be submitted before 8:30 a.m. on the first day of goods entry. Failure to do so will result in the stand being sealed until the documentation is presented.

For safety reasons, and as a general and permanent preventive measure due to the nature of the activities involved, it is **compulsory to wear a protective helmet, high-visibility vest and safety footwear during the assembly and dismantling phases of fairs and events in all exhibition areas.**

The assembly rules shall be those included in the General Rules for Participation by Exhibitors in Events Organised by IFEMA MADRID.

IMPORTANT INFORMATION

Blind perimeter enclosures along corridors may not exceed 50% of each façade or corridor. To construct longer enclosures, these must be set back a minimum of 3 metres towards the interior and may not exceed 80% of the length of the façade.

Signs, flags and spotlights may not protrude more than 50 cm from the allocated space, and from a minimum height of 2.5 metres, nor may they exceed a maximum height of 4 metres around the perimeter. Spotlights must be directed towards the interior of the stand. If you have any questions, please consult IFEMA's Exhibition Services Department.

FREE DESIGN STANDS

Segunda planta.
Máxima ocupación segunda planta.

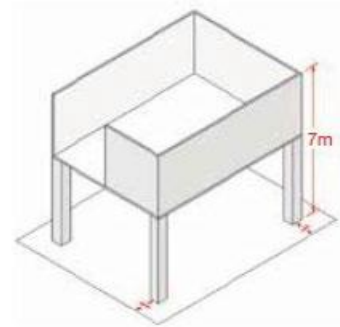

Normativa de alturas.
Máxima ocupación espacial a ocupar con cualquier elemento.

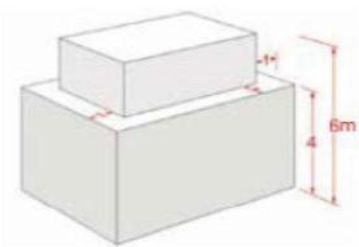

Cerramientos.

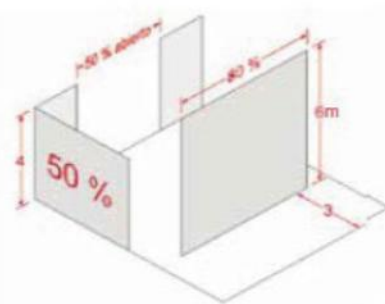

SPECIFIC ASSEMBLY RULES FOR FREE-DESIGN STANDS

Height

- Maximum authorised height within the perimeter line. 4 m
- In order to raise or hang any decorative element to a maximum height of 6 m, a 1 m margin must be left within the inside of the perimeter of the whole stand.
- This possibility does not exist in the connecting nuclei between halls, nor on the entrance sides of Halls 9 and 10.
- Building elements, decoration and spotlights may not protrude more than 50 cm from the allotted space and from a minimum height of 2.5 m.

Blind perimeter walls in the perimeter environment

- Blind perimeter walls cannot make up more than 50% of each side facing an aisle.
- Longer walls must be set back at least 3 m from the perimeter and cannot make up more than 80% of the length of the façade.

Second Floor

- The maximum permitted height for two-storey stands is 7 m in the halls.
- The second floor must be set back 1 m within the entire perimeter of the stand.
- It is not permitted to build a second floor in the connecting nuclei between the halls and in the side entrance areas to Halls 9 and 10.
- They must present a certificate specifying the dimensions, the load of use and the seating capacity, it being the sole responsibility of the exhibitor to comply with the limits established therein.

The interpretation and application of the regulations for each individual case is the responsibility of IFEMA MADRID, which reserves the right to arbitrate on exceptions, if it deems necessary, on the basis of respect for the general appearance of the Fair and the visibility of neighbouring stands.

DESING YOUR STAND WITH US

In addition to turnkey stands, we offer a comprehensive stand design service tailored to your specific needs, with our full guarantee. We handle everything— from space planning and design to assembly and dismantling. Request a customized project free of charge and without obligation by emailing standbuilding@ifema.es

1.7 Participation fees

FREE DESIGN STANDS - FLOOR ONLY	
Space	
From 16 sq.m to 50 sq.m	175/sq.m + VAT (1)
From 50,50 sq.m to 100 sq.m	170€/sq.m + VAT (1)
From 100,50 to 250 sq.m	163€/sq.m + VAT (1)
From 250 sq.m	160€/sq.m + VAT (1)
Second floor	94€/sq.m + VAT (1)
Outdoor space	157€/sq.m + VAT (1)
Corridor space	116€/sq.m + VAT (1)
Services	
Civil liability insurance (covers up to €60,000)	72,84€ + VAT (1)
Multi-fair insurance (covers up to €50,000)	69,15€ + VAT (1)
Minimum electricity consumption (0.13 kW/sq.m)	7,65€ + VAT (1)
Assembly rights	
Type A: spaces without decoration, or covered with carpet or wooden flooring	2,77€/sq.m + VAT (1)
Type B: basic modular stands made of aluminium or similar material	5,56€/sq.m + VAT (1)
Type C: modular aluminium design stands, carpentry stands and other materials	8,85€/sq.m + VAT (1)

MODULAR STANDS	
Basic turnkey stand	
Basic 16 sq.m	4.170€ + VAT (1)
Sq.m adicional stand llave en mano Basic	260€/sq.m + VAT (1)
Premium Stand	
Premium 16 sq.m	4.995€ + VAT (1)
Sq.m adicional stand Premium	307€/sq.m+ VAT (1)
Startup Stand	
Stand 6sq.m (non-expandable)	1.600€ + VAT (1)

(1) Companies based in Spain (excluding the Canary Islands, Ceuta and Melilla): 10% VAT not included. For other companies this operation is not subject to Spanish VAT. For companies based in the European Union, the exhibitor shall be liable to VAT and may, if applicable, claim it back in the country where the company is domiciled.

OTHER SERVICES	
PLAN EXPOSITOR CONECTA (liveconnect)	430€ + VAT (1)
High rate for co-exhibitors	430€ + VAT (1)
Additional exhibitor badges	19€/ud. +VAT (1)
Product nomination Innovation Gallery	400€/ud. +VAT (1)
Participation in forum activities	470€/ud. +VAT (1)

1.8 Deadlines and payment

Discounts:

5% DISCOUNT ON SERVICES CONTRACTED THROUGH THE EXPO AREA, UP TO 30 DAYS BEFORE THE START OF THE ASSEMBLY.

This discount will also be applicable to services contracted by sending the plan of your stand to the technical secretariat. Not included are the mandatory minimum services outdoor advertising, meeting rooms, graphic decoration of stands or specific fair services such as exhibitor passes, invitations....

Surcharges:

25% increase for contracting services, including assembly fees, requested 7 days prior to the start of assembly (November 11, 2026).

DATES FOR PAYMENT

- **First 50%** of the contracted space upon receipt of the space allocation.
- **October 18, 2026:** deadline for payment of 100% of the contracted space and services.

You can pay in the following ways:

- ❖ Transfer to: IFEMA MADRID / MATELEC 2026

Santander: IBAN ES64 0049 2222 5115 1000 1900 SWIFT: BSCHEMM
 BBVA: IBAN ES89 0182 2370 4000 1429 1351 SWIFT: BBVAESMM
 Caixa Bank: IBAN ES93 2100 2220 1102 0020 2452 SWIFT: CAIXESBBXXX

Send a copy of the bank receipt to servifema@ifema.es

- ❖ Certified check made out to IFEMA MADRID/MATELEC 2026.
- ❖ Credit card in a secure environment, accessible at the end of the online completion of the participation application form, or later through **Expo Zone**. In accordance with current regulations, payments in cash or bearer checks are not accepted.

In **Expo Zone** you will find your **statement of accounts** for participation in the fair and the invoices, once the payments have been made. If you need an invoice to make a payment, please request it by mail to servifema@ifema.es

1.9 Specific fair regulations

These Specific Regulations are complemented by the General Regulations for Exhibitor Participation in Events Organized by IFEMA MADRID, which all exhibitors accept by participating

- The **minimum space** for booking is **16 s.q.m.**
- The event management reserves **the right to modify the assigned spaces or make changes to the layout of the halls** for organizational reasons.
- Without prejudice to the MATELEC Management informing exhibitors in the event of relocation or significant alteration of the reserved location, **each exhibitor is obliged to inform himself** of the location of his stand, its exact dimensions, etc.
- Any exhibitor **who has not paid the full fee for the space booked** as well as any costs for services requested, shall not be permitted to either occupy the stand space or have the modular stand delivered.
- Access will not be granted to **any exhibitor or visitor who cannot prove they belong to the participating professional groups**, even if they hold the relevant pass or invitation.
- The exhibitor **must not leave their stand unattended** and must remain with the products on display throughout the entire period and opening hours of the exhibition. Non-compliance with this regulation could mean losing the right to preferential renewal of the allocated space.

- **The direct sale** of any items displayed at the fair **is strictly prohibited.**
- Exhibitors authorise IFEMA MADRID **to reproduce all or part** of their stand and the products, services and activities carried out therein.
- The exhibitor **undertakes to comply with the rules and guidelines** for protecting the environment.
- Activities that may disturb other exhibitors are prohibited, and noise levels must not exceed 60 decibels.
- Promotional activities, distribution, and display of samples, brochures, flyers, and all promotional materials must take place **exclusively within each exhibitor's designated space.**
- If **catering services** are required during the CONSTRUTEC event, the exhibitor must fill out the "Notification for catering at stands" form available at ifema.es and send it to catering@ifema.es
- Exhibitors are expressly **forbidden** from **setting up Wi-Fi** access points for Internet connections or other functionalities. This measure is to avoid interference with independently installed Wi-Fi points and IFEMA MADRID's access points. Such interference could cause Wi-Fi networks to malfunction. For more information, see Article 33 of the General Regulations for Exhibitor Participation in Events Organized by IFEMA MADRID..

1.9 Specific fair regulations

CONFIRMATION OF SPACE

Once a proposal of location and surface area has been accepted, the Application for Participation constitutes a non-revocable commitment by the applicant.

Once the final details of the application have been agreed upon, the exhibitor will receive from the Show Management the corresponding Exhibition Contract with the statement of accounts and plan of location and dimensions of the stand/s, as well as all the information on the services offered by IFEMA MADRID, which will allow him/her to make the most of his/her presence at the fair.

It is essential to make the payments indicated in the participation application form within the established deadlines.

CANCELLATION

The Exhibitor's withdrawal from participation in the Show shall be grounds for termination of the contractual relationship between IFEMA MADRID and the Exhibitor for all purposes. The resignation must be communicated to the Show Management in writing addressed to the same and will entail the loss of the amounts that the exhibitor should have paid at the date of communication, according to the schedule of payment deadlines reflected in the Application for Participation.

If the cancellation has been communicated to the Show Management within thirty days prior to the opening of the event, IFEMA MADRID may require the exhibitor to pay the full amount of the contracted space.

In relation to the additional services offered by IFEMA MADRID that the exhibitor had contracted prior to the communication of the cancellation, the cancellation charges established in article 7 of the general conditions of admission and contracting in events organized by IFEMA MADRID will be applicable.

In the event of cancellation of the fair due to force majeure, the amounts paid for concepts related to on-site participation will be refunded, according to Article 15 of the **General Rules of Participation** in events organized by IFEMA MADRID.

ASSEMBLY AND DISMANTLING

The **assembly of the free design stands** can be carried out from **November 18 to 21, 2026** in the following schedule:

- ✓ November 18 to 20 from 8:30 a.m to 9:30 p.m.
- ✓ November 21 from 8:30 a.m to 7:30 p.m.

The **entry of goods and decoration material** will take place on **22nd and 23rd November 2026 at the following times:**

- ✓ November 22nd from 8:30 a.m to 7:30 p.m.
- ✓ November 23rd from 8:30 a.m to 9:30 p.m.

From 7:00 p.m onwards, entry will only be possible through the pedestrian gates, closing the goods gates to proceed with the installation of recyclable carpeting.

EXHIBITORS WHO HAVE NOT PAID IN FULL FOR THE SPACE CONTRACTED AND THE COSTS OF THE SERVICES REQUESTED WILL NOT BE AUTHORIZED TO OCCUPY THE SPACE OR THE TURNKEY STANDS ORDERED.

For incidents with **Exhibitor Passes**, accreditation counters will be set up at the South and North Gates from November 17th to 20th from 9:30 a.m to 7:30 p.m.

The exit of goods and decoration material may be made on November 26th from 7:00 to 12:00p.m. From 7:00 p.m. to 8:30 p.m., exit will only be possible through the pedestrian doors for the removal of recyclable carpeting. After this time, the merchandise gates will be opened until 12:00p.m.

Stands may be dismantled:

- ✓ **November 27th, 2026 from 8:30 a.m to 9:30 p.m**
- ✓ **November 28th, 2026 from 8:30 a.m to 7:30 p.m**

1.9 Specific fair regulations

General assembly regulations

All companies are obliged to assemble their stand, including at least the dividing walls with the pavilion wall and with the adjacent stands, depending on their location.

For **safety** reasons, and as a general and permanent preventive measure due to the concurrence of activities, **it is mandatory to wear a protective helmet, high visibility vest and safety footwear during the assembly and disassembly phases of fairs and events in all exhibition areas.**

During assembly, it is not necessary to carry passes; therefore, there are no assembler's passes.

No assembly work may begin without the prior completion and submission to IFEMA of the Protocol "[Prevention of Occupational Risks and Coordination of Business Activities](#)" available on the website of IFEMA MADRID ifema.es - Exhibitors -Participation Rules -Forms (Article 15 of the general rules for participation in fairs organized by IFEMA MADRID. available at IFEMA MADRID ifema.es website ifema.es -Exhibitors -Participation Rules -Forms (Article 15 of the general rules for participation in fairs organized by IFEMA MADRID. available at IFEMA MADRID website.

Regulations for the circulation and parking of vehicles during the event: inside the fairgrounds it is expressly forbidden to keep vehicles parked in the loading and unloading areas, so that they may only be parked in the areas designated for this purpose, paying the corresponding fee, if applicable. Once the event has opened, it is not allowed to circulate with any vehicle inside the halls and the avenue, unless expressly authorized by IFEMA MADRID (article 14 of the general provisions of the General Rules of Participation of IFEMA MADRID).

Installation of recyclable carpeting in common areas: in line with IFEMA MADRID's commitment to the 2030 SDGs (United Nations Sustainable Development Goals), as indicated in the [Guide for Sustainable Participation in Fairs and Events](#), and with the aim of optimizing the process of installation and removal of recyclable fair carpeting for subsequent reuse and consequent elimination of the protective plastic at source, the schedules of entry and exit of goods must be adapted to these processes and will be reflected in the corresponding point. Thank you for your collaboration with our environmental commitment.

IFEMA MADRID carpets the aisles throughout the fair and, for reasons of sustainability, does so with reusable strips of standard sizes and, as a result, leaving a small strip of carpet free on the edges of the aisle/s that border the stands. These non-carpeted strips are part of the aisle and not of the **stands and therefore the exhibitor is not authorized to cover or decorate them.** We request the exhibitor's cooperation in respecting this decision; IFEMA MADRID staff will monitor compliance as far as possible, and will demand the removal of any carpeting that invades these strips and, if, despite the controls, the strip is invaded, **the invaded aisle space will be invoiced to the exhibitor as space.**

Management of waste and assembly and exhibition materials: all companies participating in the assembly and dismantling of stands at the fair/event must manage, as directly responsible, the waste they generate for their removal within the deadlines. IFEMA MADRID will make available the possibility of hiring containers to facilitate the selection and removal of waste and will supervise the same (see rates in Customer Portal [Expo Zone](#), in Contracting Services, section on cleaning and waste containers).

The exhibitor shall lose any right to claim for loss or damage to materials still remaining in the exhibition areas of the pavilion after the deadline and shall bear the costs related to their removal, which will be invoiced by IFEMA MADRID in accordance with the established rates (see art. 35 of the general regulations for exhibitors' participation in events organized by IFEMA MADRID).

AUTHORIZATIONS

On the ifema.es website, you will find a list of other services, regulations and forms that may be of interest to you:

- Communication for the realization of catering in stands.
- Occupational risk prevention and coordination of business activities.
- Application for authorization of private security guards at stands. Authorization request for wifi installation.
- Authorization request for antenna cabling.
- Request for authorization to hang structures/rigging.

<https://www.ifema.es/en/support/exhibitors-ifema-fairgrounds>

1. HOW TO PARTICIPATE

1.10. Calendar

When	What	How	Who attends you
Until April 20, 2026	Application for participation (priority deadline for choice of space)	Complete the online application form to participate in the first space allocation. - Payment of 50% of the amount of the space is compulsory upon the reception of the space allocation and contract , to confirm the space allocated.	Address of the event: matelec@ifema.es IFEMA MADRID Exhibitors: (+34) 917223000 – atencionalcliente@ifema.es
From April 20, 2026	Application for participation	- Continuation of the process of receiving requests for participation. - Offers of space from the second half of May 2026, award and dispatch of Participation Contracts.	Address of the event: matelec@ifema.es IFEMA MADRID Exhibitors: (+34) 917223000 – atencionalcliente@ifema.es
Until October 18, 2026	Payments	- Payment of 50% of the amount of the space is compulsory upon the reception of the space allocation and contract , to confirm the space allocated . - Until October 18, 2026: 100% of the amount of the space and contracted services.	Servifema: servifema@ifema.es IFEMA MADRID Exhibitors: (+34) 917223000 – atencionalcliente@ifema.es
Until October 18, 2026	Free design projects	Deadline for uploading free design projects to the Expo Zone. If the project includes hanging elements, you must submit a separate project and send it to inspeccion.rigging@ifema.es	Technical Secretariat IFEMA MADRID Exhibitors: (+34) 917223000 – atencionalcliente@ifema.es
Until October 18, 2026	Customization of modular stands	- Submit projects for interior decoration of modular stands. - Last day to choose the color of the carpet through the Expo Zone : 2 WEEKS BEFORE START OF ASSEMBLY (November 3rd, 2026). - Last day to complete the labeling of your booth in the Expo Zone: 1 WEEK BEFORE START OF ASSEMBLY (November 3rd, 2026). - Deadline to modify through Expo Zone the partial plan of your booth indicating the location of walls, coat racks, shelves, furniture, etc.: 1 MONTH BEFORE START OF ASSEMBLY (October 18th, 2026). - You should consult Expo Zone for the project of the modular stand or upload the same with the stipulated modifications.	Technical Secretariat IFEMA MADRID Exhibitors: (+34) 917223000 – atencionalcliente@ifema.es
Until October 18, 2026	Contracting of services	Services contracted with a 5% discount.	Technical Secretariat IFEMA MADRID Exhibitors: (+34) 917223000 – atencionalcliente@ifema.es

1. HOW TO PARTICIPATE

1.10. Calendario

When	What	How	Who attends you
As of November 11, 2026	Contracting of services	25% increase on prices for last minute contracting of assembly rights and all other services.	IFEMA MADRID Exhibitors: (+34) 917223000 – atencionalcliente@ifema.es
November 18 to 21, 2026	Stand assembly	<ul style="list-style-type: none"> - From November 18th to 20th from 8:30 a.m to 9:30 p.m. - November 21st from 8:30 a.m to 7:30 p.m. 	-
November 22 and 23, 2026	Delivery of modular stands	Starting at 8:30 a.m.	Hall manager
	Goods receipt	<ul style="list-style-type: none"> - November 22nd from 8:30 a.m a 7:30 p.m. - November 23rd from 8:30 a.m to 9:30 p.m. <i>From 7:00 p.m. onwards, entry will only be possible through the pedestrian doors, closing the goods gates to proceed with the installation of recyclable carpeting in aisles.</i> 	Hall manager
November 24 to 26, 2026	Celebration of the fair	Hours from 9:30a.m. to 18:30 p.m.	-
November 26, 2026	Goods issue	From 7:00 a.m to 12:00 p.m. From 7:00 p.m. to 8:30 p.m., exit will only be possible through the pedestrian gates for the removal of recyclable carpet. After this time, the merchandise gates will be opened until 24:00h.	Hall manager
November 27 and 28, 2026	Dismantling of stands	<p>Schedule:</p> <ul style="list-style-type: none"> • November 27th from 8:30 a.m to 9:30 p.m. • November 28th from 8:30 a.m to 7:30 p.m 	Hall manager

2.1. Expo Zone. Manage your participation and your space. Contracting additional services. E-commerce

Acceda a nuestra área de clientes **Expo Zone** desde la web:

<http://www.ifema.es/matelec> para gestionar los datos de su empresa, sus contactos y todo lo relativo a su participación. Podrá acceder a su participación una vez confirmada la misma con su usuario (correo con el que cumplimentó la solicitud).

What can I do from Expo Zone?

- Access details of each participation, floor plans, and projects.
- Access the exhibitor’s calendar.
- View documents of interest.
- Manage exhibitor passes and request visa support letters.
- Download discount vouchers: Renfe, Iberia, Iryo.
- Send invitations.
- Register co-exhibitors.
- Access orders, payments, account statements and invoices issued.
- Upload free design stand projects.
- Request the distribution of modular stand elements, such as coat racks or shelves, add the sign, and choose the carpet color.
- Access e-commerce for contracting services.

2.2. Registration of CO-EXHIBITORS

The registration of co-exhibitors must be done by the exhibitor from the Expo Zone, section “Manage your participation/Attach co-exhibitors”.

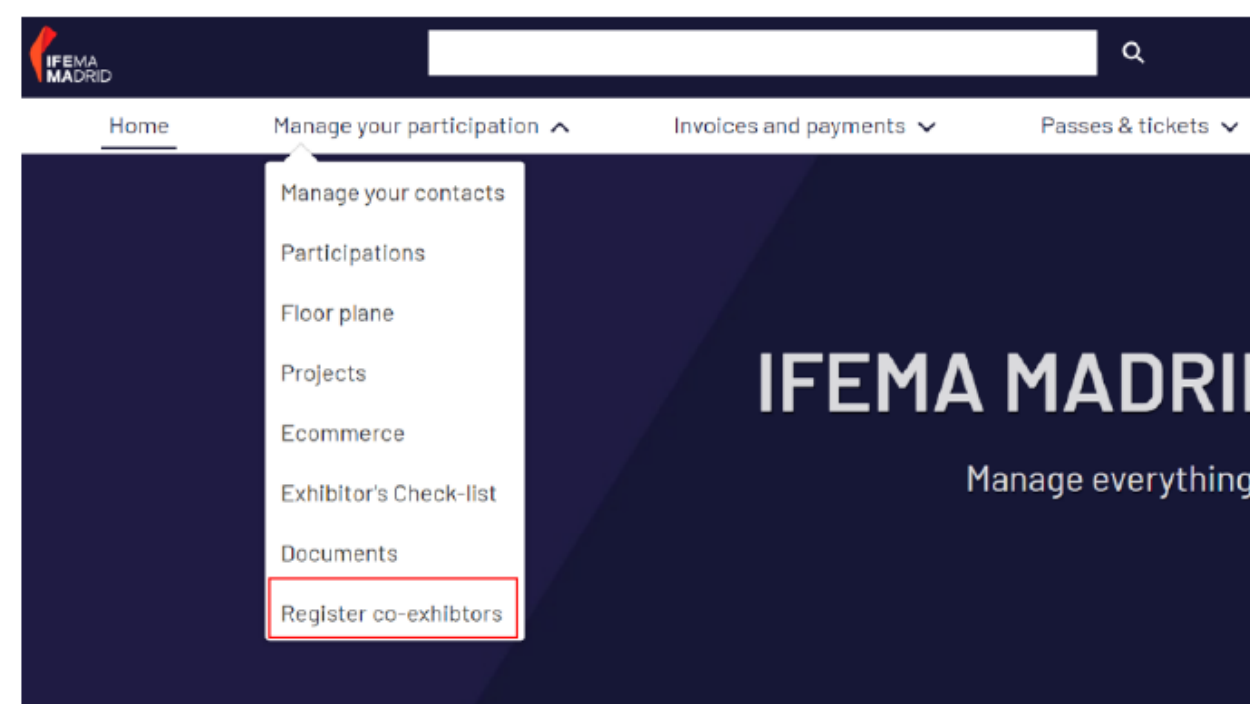

To register, it is essential to enter a correct and unique e-mail address for each co-exhibitor and indicate whether the participation fee (PLAN CONECTA) will be paid by the exhibitor or by the co-exhibitor.

The condition of co-exhibitor implies the obligatory contracting of the elements included in the CONECTA PLAN (Marketing and Communication Pack + liveconnect):

Registration fee per co-exhibitor 430,00€ + VAT (1)

Once this process has been completed, the co-exhibitor will receive a unique code to be included in his/her participation application*.

***If the exhibitor assumes the cost of participation of the co-exhibitor, his registration will be confirmed with the sending of the participation application (essential requirement).**

***If the co-exhibiting company assumes the cost of its participation, its registration will be confirmed with the sending of the participation application and the payment of the corresponding amount.**

Each registered co-exhibitor will have at its disposal the elements included in the CONECTA CO-EXHIBITOR PLAN:

- Access to the Semana Internacional de la Electrificación y Descarbonización liveconnect.
- Presence in the online exhibitor catalog. Visibility in the official list of exhibitors accessible at ifema.es/matelec.
- Access to your own **Expo Zone**.
- 2 Exhibitor Passes.
- Online invitations.

(1) Empresas establecidas en el territorio español (excluyendo Canarias, Ceuta y Melilla): 10% de IVA no incluido. Para el resto de empresas esta operación queda no sujeta a IVA español. En caso de empresas de la Unión Europea, el expositor será responsable del IVA que, en su caso, se devengue en su país de establecimiento.

2. MANAGE YOUR PARTICIPATION

2.3. Exhibitor/co-exhibitor passes, transport discount vouchers, visas and invitations

EXHIBITOR PASSES

Exhibitor passes will be managed from **Expo Zone**, in the section "Access to the event/Exhibitor passes".

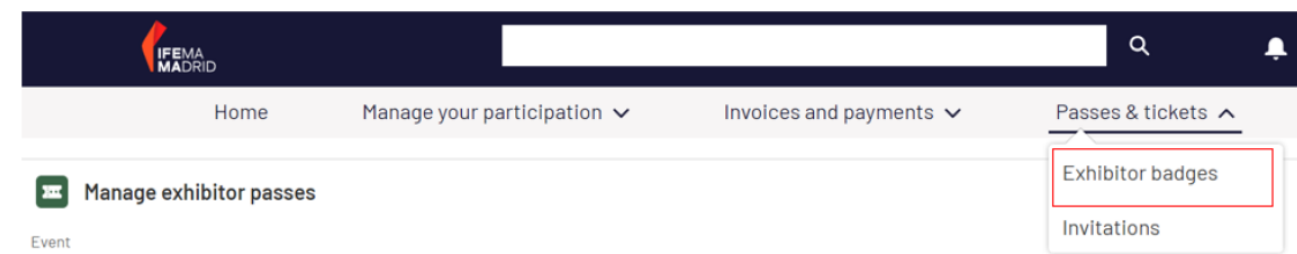

Each exhibitor will be assigned the passes that correspond to the contracted area:

- From 16 to 50 m²6 exhibitor passes
- From 50.5 to 100 m²12 exhibitor passes
- From 100.5 to 250 m².....24 exhibitor passes
- More than 250.5 m².....30 exhibitor passes

In order to ensure professionalism at the fair, all exhibitor badges will be personalized: they will include the name of the badge holder, company and country. In order to avoid misuse, identity checks may be carried out at the entrances to MATELEC.

Exhibitors may purchase additional exhibitor passes (€19/each +VAT) through Expo Zone.

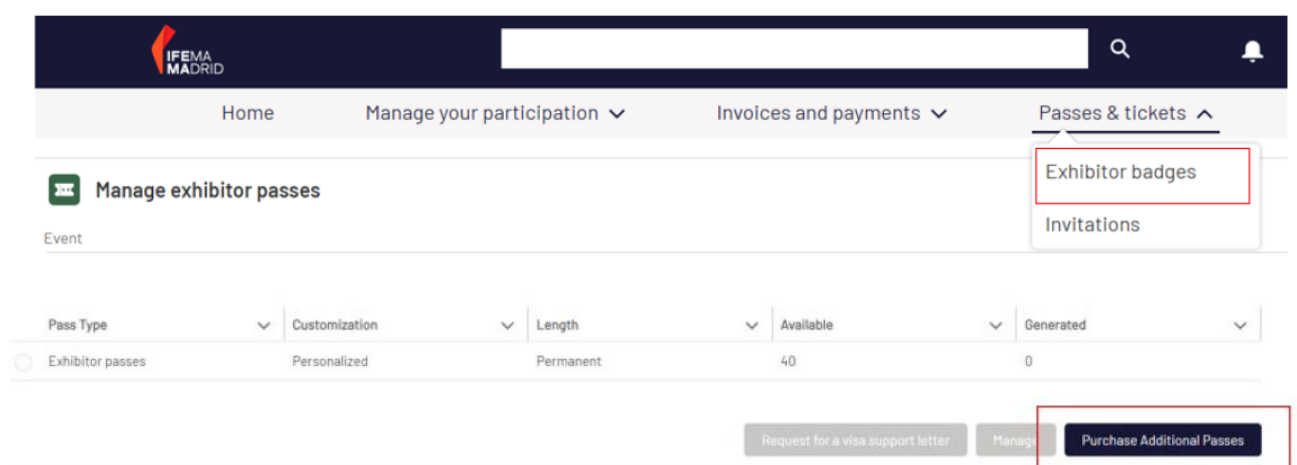

CO-EXHIBITOR PASSES

The co-exhibitor must manage their **2 exhibitor passes** in the **Expo Zone** :

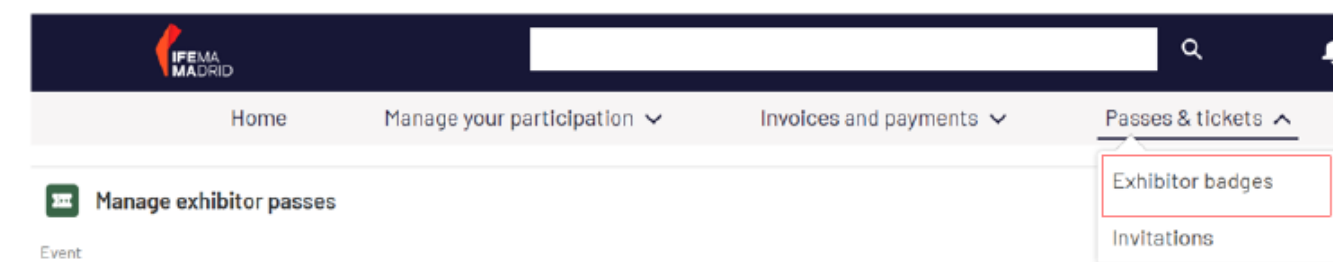

2. MANAGE YOUR PARTICIPATION

ON-LINE INVITATIONS

Each exhibitor will be issued on-line invitations to send to their contacts.

Exhibitors may purchase additional invitations by sending an email matelec@ifema.es, to the event requesting the exact.

Invitations will be sent through "[Expo Zone](#) /Access to the event/Invitations/Manage invitations".

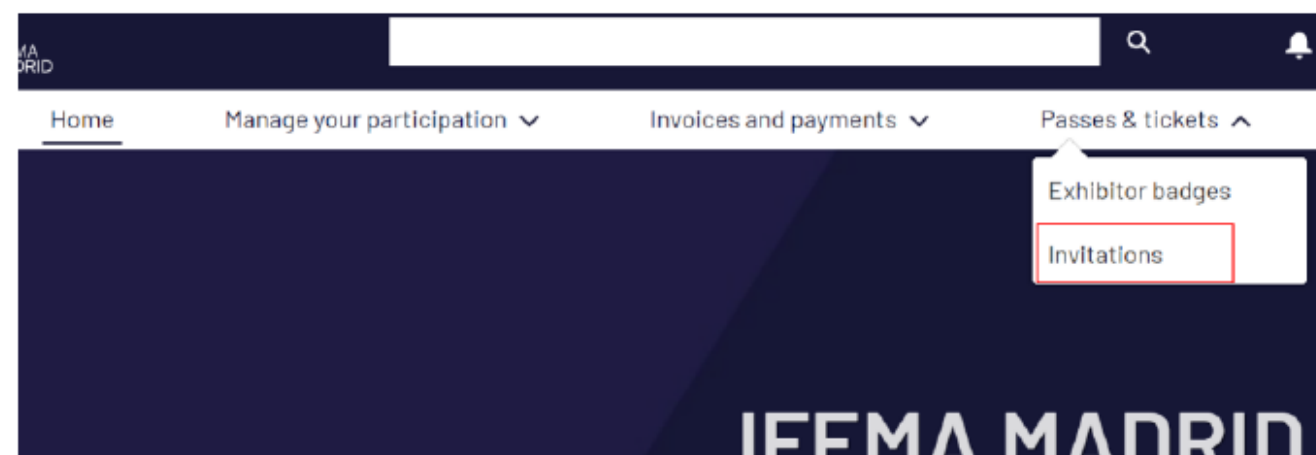

Following screen will appear for you to customise the sending:

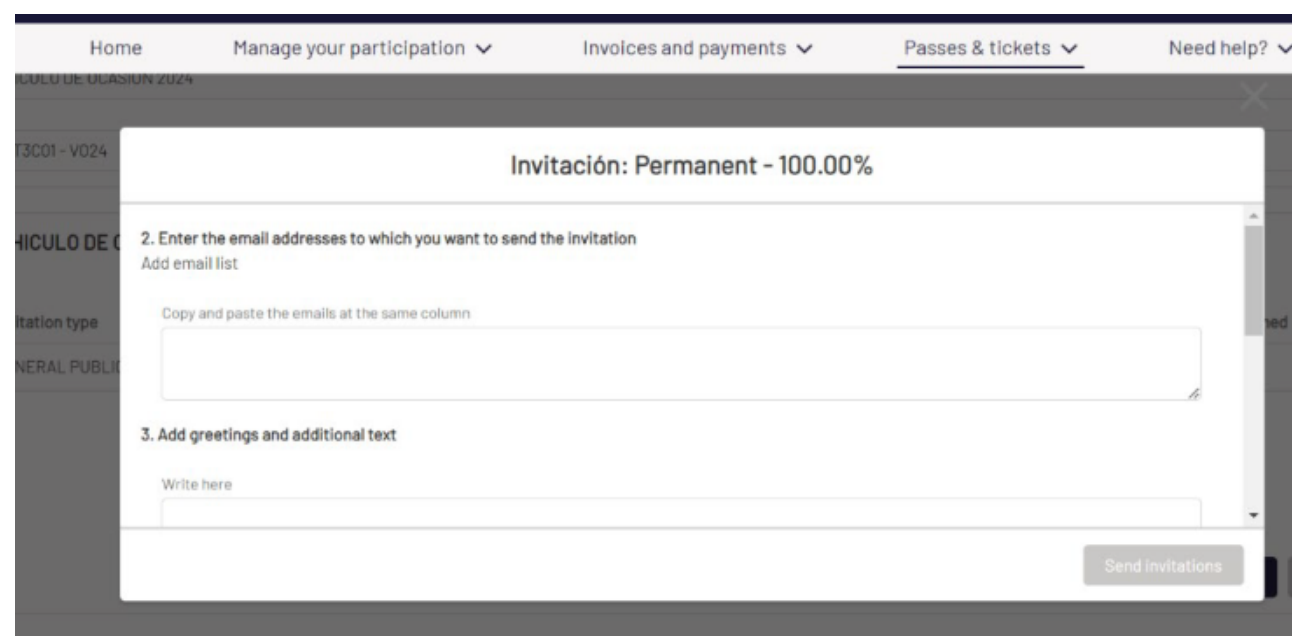

We appeal to exhibitors to make good use of the invitations, sending them exclusively to professionals of the sector in order to guarantee the professionalism of the fair. Access controls may be carried out for this purpose.

Professionals who receive the invitation code must register ONLINE through the MATELEC website, ifema.es/matelec, in the "Purchase your pass" section and enter the invitation code received to obtain their free pass to access the fair. (Invitation codes cannot be redeemed at the counter).

It will be absolutely necessary for all Professional Visitors who are going to access the exhibition site with a Professional Invitation, to be accredited as Professionals, through ifema.es/matelec

VISA MANAGEMENT

Si requiere visado para viajar, **puede solicitar desde Expo Zone, las cartas de apoyo** para gestionarlo. Para ello **debe personalizar previamente el pase de expositor** y haber **formalizado el pago** de su participación siguiendo el calendario de pagos (ver punto 1.8).

If you require a visa to travel, **you can request from Expo Zone, the letters of support to manage it.** To do so, you must **first customize** the exhibitor pass and have formalized the payment of your **participation following** the payment schedule (see point 1.8).

Once these two requirements are fulfilled, from "[Expo Zone](#) /Event Access/Exhibitor Passes" you will have access to the "Request visa support letter" button.

We advise you to start the process as soon as possible since the deadline for visa application is usually at least 30 days before traveling.

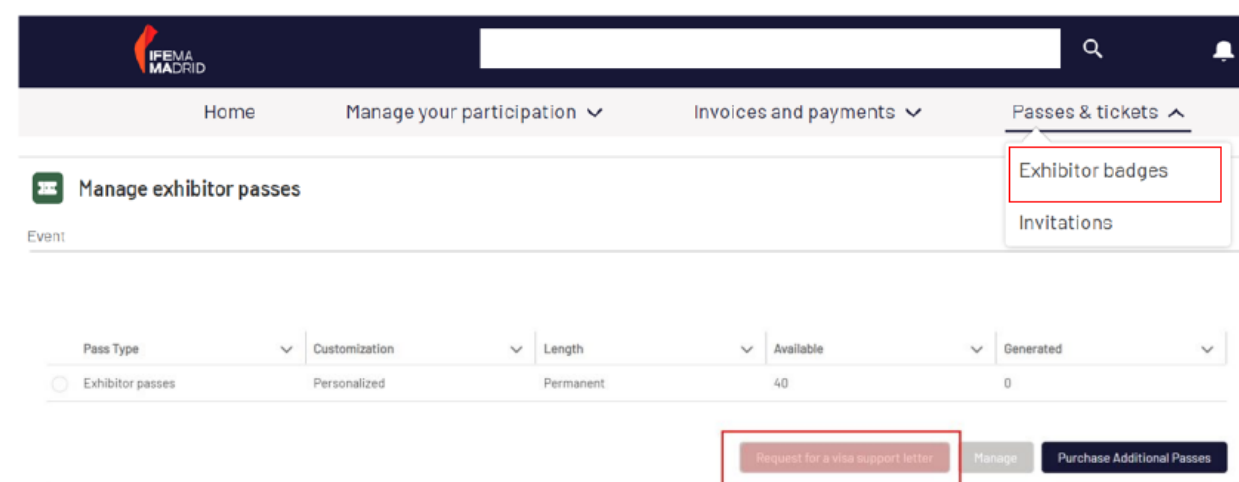

TRANSPORT DISCOUNT VOUCHERS

Once the exhibitor badges have been requested, the **corresponding discount vouchers for transportation can be downloaded from from Expo Zone**, in the section "Manage your participation/Documents".

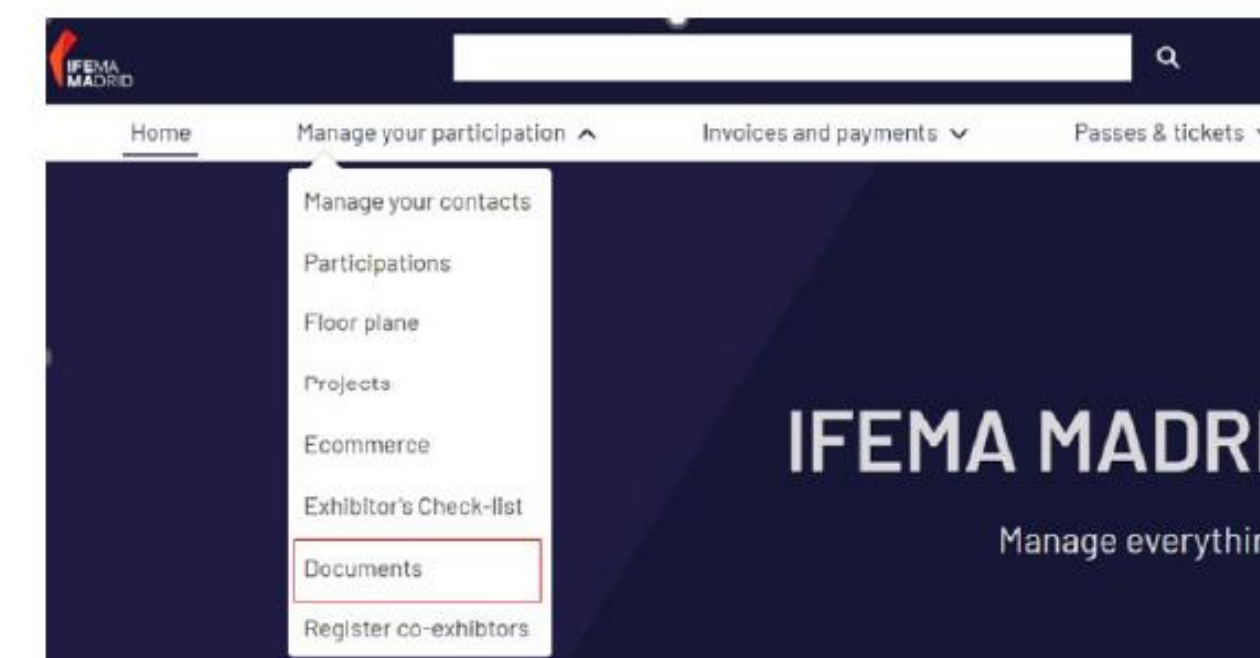

2.4 Other relevant information

Shipment of merchandise to the premises. Customs regulations.

IFEMA MADRID staff is not authorized to receive any goods destined for your stand. In order to send goods to the venue, the exhibitor must indicate in the delivery address:

- ♦ IFEMA MADRID (Avda. del Partenón, 5. 28042 Madrid. España)
- ♦ MATELEC Fair
- ♦ Name of your company.
- ♦ Hall and stand number.

The goods must be received by your company's personnel at your stand and must arrive during the days destined for the entry of goods and decoration.

In case it is not possible to comply with the above, we recommend you to contact our partner company for goods management (handling and warehousing):

DB Schenker office at IFEMA Trade Fair Center MADRID: Pavilion
7Phone: +34 91 330 51 77
ifema.madrid@dbschenker.com

CUSTOM REGULATION

1. All products coming from non-EU countries must go through customs procedures, with special mention to the fact that, since 1 January 2020, the United Kingdom has been treated as a third country, so all shipments originating from the United Kingdom must regularise their merchandise through the corresponding customs procedure.
2. Exhibiting companies must have the details of the customs agent clearing their goods or, failing this, a copy of the customs documentation for entry into the European Union.
3. The material or merchandise for distribution or consumption is subject to Spanish taxes, even if they are products with no commercial value (depending on the country, the amount of taxes may vary).
4. All goods subject to a temporary regime must not be moved from the stand or leave the IFEMA MADRID trade fair centre until their situation has changed and customs formalities have been completed. It may only be deposited during these formalities in the warehouse of the official logistics agent within the trade fair centre.
5. It is strictly forbidden to sell or distribute non-Community goods at a trade fair before customs clearance has been completed.

6. Products transported as hand luggage must be declared at Barajas Airport in the RED CHANNEL ("Something to declare") and the goods must be cleared with the corresponding authority at the airport.
7. Goods that have not passed customs control and are on display will be confiscated by the customs authorities operating at the Trade Fair Centre until the appropriate documents are presented.
8. Any lorry arriving at IFEMA MADRID under a transit consigned to IFEMA MADRID, must go to the warehouse of the official Logistics Operator, for the regularisation of the transported goods, located at:

Avenida Partenón s/n
Entrada Oeste - Access on calle Rivera del Sena
Pabellón de servicios nave 2
28042 Madrid

In order to avoid undesired incidents, and for any questions you may have, please contact our Customs Operator, DB SCHENKER: (+34) 91 330 51 77: email: ifema.madrid@dbschenker.com

2. MANAGE YOUR PARTICIPATION

2.5. Map



2.6. FAQ's

Question	Answer
<p>Where can I consult the IFEMA MADRID General Rules of Participation to which my participation is subject?</p>	<p>In addition to the Exhibitor's Guide, your participation in MATELEC is subject to the IFEMA MADRID General Rules of Participation, which you should be informed about and which you can access from the IFEMA MADRID website (www.ifema.es) as well as from the following link IFEMA MADRID General Rules of Participation.</p>
<p>Can I hire a catering service or serve my own food and beverages at the stand?</p>	<p>Yes, exhibitors who are going to offer, free of charge, a catering service on their stand may do so either by submitting their request to the catering companies approved by IFEMA MADRID (Consult the list HERE) or through other catering service providers, in which case it is essential to complete the form 'Communication for the provision of catering services on stands' available in the exhibitors' area of the institutional website and send it, with the information requested therein, to catering@ifema.es for its knowledge and appropriate effects. If IFEMA MADRID is not notified of the above, the Exhibitor will not be able to offer this service at its stand. The Exhibitor assumes liability to third parties for claims arising from the aforementioned catering service, exonerating IFEMA MADRID from any liability in this respect.</p> <p>Catering Parking/Refrigerated Trucks: There is a parking area for catering vehicles and refrigerated trucks, with the possibility of electrical connection. You can hire it through the eCommerce</p>
<p>Can I extend the trade fair day by having a fun afterwork on my stand after the at my stand after the end of the fair ?</p>	<p>The celebration of a recreational afterwork outside exhibition hours is subject to prior authorization. They may only be held on November 18 and 19, at the close of the fair (7:00 p.m) until 9:00 p.m.</p> <p>It is essential to send the authorization request to matelec@ifema.es</p>
<p>Can I access the trade fair centre with vehicles for assembly and disassembly or loading and unloading of goods?</p>	<p>Access to IFEMA MADRID and to the interior of the halls will be through the doors and on the days and times indicated in this Exhibitor's Guide. Access to the inside of the halls will be exclusively for unloading materials. Vehicles may not remain parked inside the halls or in adjacent areas.</p> <p>We remind you that, for occupational safety reasons, it is strictly forbidden to park in front of the goods entrance gates. IFEMA MADRID is not responsible for the surveillance of vehicles while at Feria de Madrid.</p> <p>There is a parking area for trucks and another for cars, which may be used by paying, if applicable, the corresponding fees. Consult rates</p>
<p>Can I have a vehicle on my stand?</p>	<p>Vehicles with combustion engines used for exhibition purposes must have a fuel tank filled with the minimum fuel required to access and leave the allocated space at the end of the exhibition.</p>

2.6. FAQ's

Question	Answer
<p>Can I send goods to my booth?</p>	<p>IFEMA MADRID staff are not authorised to receive merchandise for your stand. In order to send merchandise to the venue, the exhibitor must indicate the delivery address: IFEMA MADRID (Avda. del Partenón, 5. 28042 Madrid. Spain). MATELEC Trade Fair Name of your company. Hall and stand number.</p> <p>The merchandise must be received by your company's staff at your stand and arrive on the days set aside for incoming merchandise and decoration. If it is not possible to comply with the above, we recommend that you contact your freight forwarding partner: DB Schenker office at the IFEMA Trade Fair Centre MADRID: Hall 7, (+91) 330 51 77 ifema.madrid@dbschenker.com</p>
<p>What procedure do I have to follow to hang structures in the halls/rigging?</p>	<p>Exhibiting companies may hang elements from the ceiling of the halls following the procedure shown in the "Regulations for hanging structures in Halls" and by completing the form "Application for authorisation for hanging structures/rigging" and sending it to: inspeccion.rigging@ifema.es</p>
<p>Can I hold prize draws and raffles at the stand?</p>	<p>Raffles, prize draws, and random combination games are forms of gambling as set out in articles 3.2 and defined in article 15 of Law 6/2001 of 3 July on gambling in the Community of Madrid.</p> <p>All the information is available in the following form: https://sede.comunidad.madrid/comunicaciones-declaraciones/cifras-tombolas</p>
<p>How do I apply for a visa support letter?</p>	<p>Visa support letters are managed through the Expo Zone. To do so, you first have to personalise your exhibitor passes. Once you have managed your exhibitor passes, you can request your support letters and download them to your computer.</p> <p>It is essential to be up to date with payments according to the payment schedule in order to be able to apply for the letters.</p>
<p>Where can I book the services for my stand?</p>	<p>Either through the e-commerce section inside the Expo Zone or via the link: https://shop.ifema.es</p>
<p>Who do I contact to book a room?</p>	<p>Exhibitors who need to book a room should contact with: uanproduccion@ifema.es</p>

2.6. FAQ's

Question	Answer
<p>What does the CONECTA PLAN (formerly the Marketing and Communication Pack + Semana Internacional de la Electrificación y de la Descarbonización liveconnect) include?</p>	<p>This must-hire concept includes the following elements :</p> <ul style="list-style-type: none"> • Semana Internacional de la Electrificación y de la Descarbonización liveconnect. • Presence in the exhibitors' catalog available on the official website of the event. • Presence on the floor plans located in each of the pavilions. <p>And the following services:</p> <ul style="list-style-type: none"> • Access to the Expo Zone. • Exhibitor passes according to the contracted area. • Invitations and delivery service through the Expo Zone. • Wifi connection for 3 users throughout the fair for booth holders (Devices that allow connection in the 5 GHz band). • Access keys will be sent the days prior to the start of the fair.
<p>How to use the Expo Zone?</p>	<p>The following video shows a tutorial on the use of the Expo Zone</p>
<p>What are the features of my Expo Zone?</p>	<p>It is used to manage the participation of each exhibiting company in MATELEC.</p> <ul style="list-style-type: none"> • Registration of the contacts that will access the Expo Zone and management of access permissions. • Access to the exhibitor's calendar. • View documents of interest. • Manage exhibitor passes, request visa support letters and send invitations. • Register co-exhibitors. • Access to payments, account status and invoices issued. • Upload free design booth projects and distribution of modular booth elements. • Add signage and choose carpet color for exhibitors with modular booths. • Access to e-commerce for the contracting of services.

2.6. FAQ's

Question	Answer
<p>What are the features of my LIVEConnect?</p>	<ul style="list-style-type: none"> • It is used to manage the participation of the company in the liveconnect catalog and the Semana Internacional de la Electrificación y de la Descarbonización • Show product and service offerings. • Schedule appointments for professional meetings. • Sign up other team members with access to liveconnect. • Complete your professional profile on the platform and my agenda of availability for meetings. • Search for contacts of interest in the professional network. • Consult activities with the possibility of scheduling them. • View information on the offer of other exhibitors. • Scan professional visitor badges at the fair. • Request and accept to be contacted for chatting and videoconferences.
<p>How can I request my invoices?</p>	<p>Invoices are not generated by default. You must request them directly from the IFEMA MADRID invoicing department (servifema@ifema.es) indicating the event at which you are exhibiting and the items to be included in the invoice. Once it has been generated, it will be available in your Expo Zone.</p>
<p>What is the difference between floor only and turnkey stand basic?</p>	<ul style="list-style-type: none"> • Floor only: it is the exhibitor who has to make a free design stand and submit it for approval by the CONSTRUTEC Technical Secretariat or hire it through the stand design service offered by IFEMA MADRID, build a stand with us. This modality includes only the contracting of the space and the compulsory elements (insurance, minimum electricity consumption). • Modular stand: delivered assembled. The structure of the stand is made of aluminum and the panels are made of melamine. See description in section 1.6 <p>The CONECTA EXHIBITOR PLAN must be contracted, regardless of the type of assembly (floor only or modular).</p>
<p>Can I decorate and/or set up my stand with IFEMA?</p>	<p>IFEMA MADRID offers two main services:</p> <ul style="list-style-type: none"> • Graphic decoration for stands: Customize your modular stand with the image of your brand generating maximum impact on visitors. There is a wide range of versatile graphic materials adaptable to walls, furniture, fronts, banners, etc. You can request information and a quote at decoraciongrafica@ifema.es • Stand design: consists of an integral service of stand design totally adapted to your needs. From the planning of your space, design, assembly and disassembly. You can request information and budget at standbuilding@ifema.es

2.6. FAQ's

Question	Answer
Is it compulsory to attend the booth at all times?	Yes, exhibitors must not leave their stand unattended and must remain with the products on display throughout the entire period and opening hours of the event.
Are assembler's passes necessary during the set-up of the trade fair?	No. The requirements to be allowed to enter and set up are: to have paid 100% of your participation, to have the project presented and approved, to have paid the assembly fees, and to have completed the occupational risk protocol.
How can I book parking at IFEMA?	Exhibiting companies will be able to book parking spaces through the e-commerce section inside the Expo Zone or via the link https://shop.ifema.es . Once the contract has been signed, parking badges can be collected from November 12 (first day of stand set-up) at the exhibitor services desk, located in the central boulevard between halls 6 and 8.
What coverage do I have as an exhibitor with the insurance included?	You can check the coverage of the compulsory insurance policies at the IFEMA MADRID exhibitor support area .
How can I access the WI-FI network as an exhibitor?	As an exhibitor you will receive as part of the CONNECT PLAN a Wi-Fi connection for 3 users during the entire trade fair for the exclusive use of stand holders. Devices that allow 5GHz network capability are required. Access codes will be sent out during the lead up to the event. Additional Wi-Fi access can be booked through the e-commerce section inside the Expo Zone or via the link https://shop.ifema.es
Regulations and support for exhibitors at the trade fair centre	https://www.ifema.es/en/support/exhibitors-ifema-fairgrounds/
Regulations and support for fitters at the trade fair centre	https://www.ifema.es/en/support/assemblers-colaborators-fairgrounds

3. PROMOTE AND MONETISE YOUR PARTICIPATION

3.1 Exhibitor catalogue

The fair's catalogue, or list of exhibiting and co-exhibiting companies, is an essential tool for promotion and networking. It provides visitors and other exhibitors with the basic information needed to prepare for the fair and helps them find and contact you before, during, and after the event.

- Enter and update your contact details, the products or services presented, and any relevant information to give your company maximum visibility and ensure you get the most return from your participation.
- All the digital environment and communication for your participation is channeled through liveconnect.
- Make the most of the platform offered by IFEMA to promote your participation, schedule appointments, showcase your products, and connect with your target audience.

3.2. Invitations for your clients and contacts

IFEMA provides you with access invitations to the fair to efficiently promote your participation. Don't miss out on this useful tool, which is available to you in your **Expo Zone**.

3.3. Networking

Enhance your contact list

liveconnect gives you the opportunity to search for contacts among its participants. You can use filters such as country, activity, job title, products of interest, etc., to perform searches. Once you've identified potential clients, you can chat with them, request contact details (such as email and phone number), or invite them to a meeting at the fair.

Be proactive and take advantage of this opportunity to build a valuable contact list.

Meeting requests can be directed to the company in general or to a specific team member. This way, the entire team can plan their meeting schedule at the fair in advance.

3.4 Outdoor advertising

We offer you a wide range of strategically placed advertising spaces, ensuring maximum visibility for visitors and exhibitors attending the fairgrounds.

You can explore these options on the fair's website in the exhibitor area under "advertising services and promotional elements," or by sending an email to publicidad@ifema.es or by calling (+34) 91 722 53 08 / 40.

3.5 Innovation gallery

The Innovation Gallery aims to offer added **value to exhibitors and visitors by showcasing a selection** of new products and/or projects, giving maximum visibility to cutting-edge innovations in the sector.

It will be a requirement to be an exhibitor at GENERA 2026 and hold the marketing rights or the patent of the product to be presented or the express written consent of the company that owns the patent.

A fee of **470 € + VAT (1) per registered product is established**. This fee is mandatory and non-refundable regardless of the inclusion or not of the product in the Innovation Gallery.

You will be able to submit your candidacy once you receive the call and rules of this year's edition.

4. Sustainability Culture Management at IFEMA MADRID

MATELEC

At IFEMA MADRID we are not only fully committed to sustainability per se, but also to achieving the sustainable development goals (hereinafter SDGs) promoted by the United Nations, which we have incorporated into our strategic corporate management policy and culture

IFEMA MADRID's sustainability policy is mainly focused on the following SDGs: 8, 9, 11, 12, 13, 16 and 17.

IFEMA MADRID'S sustainability policy is mainly based on the following SDGs: Nos. 8, 9, 11, 12, 13, 16 and 17.

ISO Standards certified by IFEMA MADRID:

- ISO 9001: Quality Management,
- ISO 20121: Event Sustainability Management.
- ISO 14001: Environmental Management,
- ISO 50001: Energy Management,
- ISO 22320: Emergencies Management.

ACTIONS TAKEN AT IFEMA MADRID TO REDUCE GAS EMISSIONS AND BE MORE ENERGY EFFICIENT:

- 100% certified electrical energy of renewable origin.
- Geothermal installation in Puerta Sur building.
- Low consumption lighting in our halls and on our modular stands.
- Controlling the temperature of our air-conditioning / HVAC systems.

IFEMA MADRID is in possession of "calculo" (I calculate) and "reduzco" (I reduce) stamps in Carbon Footprint Scopes 1 and 2.

WASTE MANAGEMENT:

• The exhibitor/assembler is the generator of the waste and shall therefore be responsible for its removal and management. How the waste generated by the exhibitor is managed is explained in article 35 of the General Rules of Participation.

• We offer our exhibitors a service that includes the removal and management of the waste they/their assemblers generate. (check our fees in Exhibitors' Area).

Carpet recycling:

IFEMA MADRID recycles 100% of the carpeting used in aisles and communal areas. To do so it has been essential to change our assembly and disassembly process, that affects the entry and removal of goods (check the corresponding item) . Furthermore, means that it has to be laid in strips instead of covering the entire surface area as was previously the case. This means we can guarantee its conversion into a new raw material for the subsequent manufacture of other products.

SUSTAINABLE MOBILITY:

IFEMA MADRID offers access to public transport close to its facilities (metro and bus), parking for electric cars with 100% renewable electricity charge points, as well as a parking area for bicycles and scooters

GUIDE TO SUSTAINABLE PARTICIPATION IN TRADE FAIRS/EVENTS:

IFEMA MADRID has published its Guide to Sustainable Participation in Trade Fairs for exhibitors on its website. We recommend you read it before starting to prepare your participation:

ifema.es/en/about-us/quality-sustainability



Department	Ask me about	Contact		
Commercial Department	<ul style="list-style-type: none"> Contracting space General topics of participation in the fair Exhibitor passes Trade visitor invitations Activities and forums at the Fair. 	Director	Alberto Leal	(+34) 91 722 30 00 matelec@ifema.es
		Commercial Managers	Yolanda Cruz Marta Ariste - International Area	
		Commercial Area	Virginia Montouto Ernesto Gil - Marketing and advertising	
IFEMA MADRID Customer Service	<ul style="list-style-type: none"> Hiring of services Expo Zone Visitor information 	(+34) 91 722 30 00 atencionalcliente@ifema.es		
Technical Secretariat (Trade Fair Services Department)	<ul style="list-style-type: none"> Technical support to exhibitors and assemblers Review of stand assembly projects Solutions to technical problems during the exhibition activity Customization of modular stands 	(+34) 91 722 30 00 stecnica@ifema.es		
Graphic decoration	Hiring of graphic materials to customize your booth	(+34) 91 722 30 00 decoraciongrafica@ifema.es		
Graphic decoration	Design and assembly of free design stands	(+34) 91 722 30 00 standbuilding@ifema.es		

Department	Ask me about	Contact
Outdoor Advertising	Hiring of advertising media at the fairgrounds	(+34) 91 722 53 40/08 publicidadexterior@ifema.es
Communication and Marketing Management	Media relations	<div style="display: flex; justify-content: space-between;"> <div> <p>Director: Raúl Díez Press officer: Pablo Santos International press: Elena Valera Press secretariat: Pilar Serrano</p> </div> <div> <p>Tlf.: (34) 648 162 918 Email: psantos@ifema.es</p> </div> </div>
Planning and Control Management	<ul style="list-style-type: none"> Rental of the different meeting and convention spaces at the fairgrounds, both during and outside the fairs. Coordination of extra-fair activities 	(+34) 91 722 30 00 uanproduccion@ifema.es
Institutional Relations (Protocol)	<ul style="list-style-type: none"> Institutional visits Guided tours Protocol for all Events Institutional relations 	(+34) 91 722 30 00 infoifema@ifema.es
Safety and Self-Protection Management	<ul style="list-style-type: none"> General security and parking Access to the Fairgrounds Coordination for stand catering 	(+34) 91 722 50 65 dseguridad@ifema.es catering@ifema.es
Medical Service and Security Emergencies	<ul style="list-style-type: none"> Medical emergency Health care for exhibitors and visitors during the celebration of fairs, set-up and dismantling. 	(+34) 91 722 54 00

Thank you

