



FITUR PARTNER

DISCOVER  
*Puerto Rico*

20-24  
Jan  
2027 / Madrid

*Where journeys  
begin.*



Exhibitor's Guide  
and Specific Rules  
of Participation

Official Airline



UN Tourism  
AFFILIATE MEMBER



# CONTENTS

1. How to exhibit at FITUR 2027?
2. Participation
  - 2.1. Participation Fees
  - 2.2. Payment dates
3. Types of participation
  - 3.1 *Solid* turnkey stand
  - 3.2 *Light* turnkey stand
  - 3.3 Regulations for turnkey stands (*solid* and *light*)
  - 3.4 Space only (Free-design stand)
  - 3.5 General regulations for assembly. Floor space only regulations
    - 3.5.1 Assembly fees
4. Exhibitor badges, transport discount vouchers, visas and invitations
  - 4.1 Exhibitor badges
  - 4.2 Transport discount vouchers
  - 4.3 Visa management
  - 4.4 Invitations
5. Specific terms and conditions of participation
  - 5.1 Specific terms and conditions of participation
  - 5.2 Co-exhibitors registration
6. Organisation
  - 6.1 Dates and times of assembly
  - 6.2 Delivery of goods to the trade fair centre
  - 6.3 Customs regulations
7. Floor Plan
8. Additional services of IFEMA MADRID
9. Important dates
10. Sustainability Management at IFEMA MADRID
11. FAQs
12. Contact Us

## 1.1.

**FITUR** will be held at IFEMA MADRID from **20 to 24 January 2027**, with opening hours from 10:00 AM to 7:00 PM on Wednesday to Friday (20–22), 10:00 AM to 8:00 PM on Saturday (23), and 10:00 AM to 6:00 PM on Sunday (24).

**Hall 12 (Knowledge Hub):** open from **20 to 22 January 2027**, 10:00 AM – 7:00 PM.

## 1.2.

Space can be booked by filling in the **online Application for Participation** form available on the trade fair website [ifema.es/fitur](https://ifema.es/fitur) together with the space reservation fee (see point 2.2)

### Exhibitors from the Previous Edition (FITUR 2026)

- ✓ **Applications to participate must be submitted along with payment of the reservation fee by 5 June 2026.** Exhibitors who meet this priority deadline will be eligible to renew their participation.
- ✓ If the exhibitor requests a change of location or area, the organisation will, if possible, make offers of space in response to such requests. Exhibitors must confirm their acceptance in writing to the Event Management within the period indicated by organisation.
- ✓ **Applications for participation received after 5 June 2026.** Exhibitor applications for participation will be dealt with in strict order of receipt and payment of the space reservation fee.

Once the final details of your application have been agreed, you will receive the corresponding Participation Agreement. We would like to remind you that payments must be settled within the established deadlines (see point 2.2).

### New exhibitors

- ✓ **Participation applications received will be handled** in strict order of receipt and payment of the space reservation fee (this last requirement is essential and will determine the date on which the exhibitor's participation application is received).

## 1.3.

Once the participation application has been submitted, the booking will only be formalised upon **receipt of proof of payment of the space reservation fee**—or 50% of the total fee if the booking is made after 14 September (the deadline for the first 50% payment. See point 2.2 for full payment deadlines).

## 1.4.

In the event that the CONTRACTING COMPANY designates another entity as the invoicing company, the details of both must be included in the application form.

**Invoicing data cannot be changed after the end of the fair**

## 1.5.

Submitting the application for participation constitutes an irrevocable commitment by the applicant and entails full acceptance of **IFEMA MADRID's General Terms and Conditions of Participation** and the generic provisions established by the Organisation of the fair.

## 1.6.

**The Application for Participation of new exhibitors** is subject to the approval of FITUR Management and to the fair's sectorisation criteria. Once the application has been received and accepted, the event team will offer the best available space that suits the exhibitor's needs. Space will be allocated after written acceptance by the exhibitor. The exhibitor will receive the Participation Agreement with the statement of accounts and plan of the stand(s). It is essential to make the payments indicated in the contract within the established deadlines.

## 1.7.

**Cancellation.** The exhibitor's withdrawal from participation in the event shall be grounds for termination of the contractual relationship between IFEMA MADRID and the exhibitor for all purposes. Withdrawal must be communicated in writing to event management and will entail the loss of the amount that the exhibitor should have paid by the notification date, in accordance with the schedule of payment deadlines reflected in the participation application.

Should the withdrawal have been communicated to the Event Management within the 30 days prior to the event opening, IFEMA MADRID may demand full payment for the space hired.

**In relation to the additional services offered by IFEMA MADRID** that the exhibitor had contracted prior to notifying of the withdrawal, the cancellation charges established in **article 7** of the general conditions of admission and contracting in events organised by IFEMA MADRID will apply.

**In the event of cancellation of the exhibition due to force majeure**, the amounts paid for concepts related to participation in the fair will be refunded, in accordance with article 15 of the **General Terms and Conditions of Participation** in events organised by IFEMA MADRID.

## 1. Participation fees

Concept	PRICING
<b>Space only:</b>	€197.40/m <sup>2</sup> + VAT
<b>“SOLID” turnkey stand</b> (16m <sup>2</sup> ): Additional m <sup>2</sup> “SOLID” turnkey stand:	€4,498 + VAT €272.30/m <sup>2</sup> + VAT
<b>“LIGHT” turnkey stand</b> (16m <sup>2</sup> ): Additional m <sup>2</sup> “LIGHT” turnkey stand:	€5,367 + VAT €326.30€/m <sup>2</sup> + VAT
Double deck:	€98.70 m <sup>2</sup> + VAT
Outdoor space:	€98.70/m <sup>2</sup> + VAT
Co-Exhibitor registration	88€/unit + VAT
Capped rate for 50 or more co-exhibitors:	4,400€ + VAT

### Participation as an exhibitor at the fair requires the contracting of the CONECTA EXHIBITOR PLAN 736€ + VAT (1)

This concept includes the following services:

- Dissemination of participation in the fair through insertion in the list of exhibitors accessible in open access on the fair website and shared as a link in sectoral communications.
- Presence as exhibitors on the fair's digital platform. The digital event extends the duration of the fair beyond its celebration, provides additional contents of the exhibition offer and sectorial news and is accessible to exhibitors and registered visitors.
- Registration of a maximum of 60 products or services associated with the company file on the digital platform.
- Presence during the fair on the hall plans and exhibitor lists.
- Access to the IFEMA MADRID 'ZONA EXPO' customer portal to manage participation
- Exhibitor passes according to the contract (see point 2.3).
- Online invitations according to the contract (see point 2.3).
- Discount vouchers for transport.

- Premium Wi-Fi connection for 3 users for the duration of the fair (these connections will only work with devices that allow connection in the 5 GHz band). The password is enabled for the duration of the fair and until the last day of dismantling and is sent by email to the holder's address at least 48 hours in advance.

Functionalities to connect with other users to generate business and networking opportunities:

- Search for new contacts among registered visitors and exhibitors.
- Communication with contacts (chat and videoconferencing)
- Organisation of personal online and face-to-face meetings with contacts
- Preparation of company meetings on the trade fair stand to optimise time
- Scanning of visitor passes at trade fairs
- Downloading of contact list with contact details

### PARTICIPATION ENTAILS CONTRACTING THE FOLLOWING SERVICES:

- **Liability insurance** (covers up to €60,000): .....€74.30 + VAT (1)
- **Multi-fair insurance** (covers up to €50,000): .....€70.53 + VAT (1)
- **Minimum electricity consumption** (0.13 kW/m<sup>2</sup>): .....€7.88 + VAT (1)
- **Assembly fees** (included in the “SOLID” and “LIGHT” turnkey stands):
- ✓ **Type A:** Spaces that are not decorated or fitted with carpeting or flooring: €2.80/m<sup>2</sup> + VAT (1)
- ✓ **Type B:** Solid modular stands made of aluminium or similar materials: €5.62/m<sup>2</sup> + VAT (1)
- ✓ **Type C:** Modular stands with aluminium design, carpentry and other materials: €8.94/m<sup>2</sup> + VAT (1)

### DISCOUNTS

#### 5% DISCOUNT ON SERVICES CONTRACTED THROUGH THE EXPO ZONE, UP TO 1 MONTH BEFORE STARTING ASSEMBLY (15 DECEMBER, 2026)

This discount will also be applicable to services contracted by sending your stand plan to the technical secretariat. This does not include the minimum mandatory services, external advertising, meeting rooms, graphic decoration of stands or specific fair services such as exhibitor passes, invitations, etc.

### SURCHARGES

**25% increase for hiring of assembly rights requested 7 days before the start of the assembly (6<sup>th</sup> January 2027).**

## 2. Dates for making payments

- **When submitting the Participation Application Form**, the space reservation fee will be paid, according to the following rates:
  - ✓ From 16 to 50 m<sup>2</sup>: .....€450 + VAT (1)
  - ✓ From 50.5 to 100 m<sup>2</sup>: .....€750 + VAT (1)
  - ✓ From 100.5 m<sup>2</sup> upwards: .....€1,500 + VAT (1)
- **14 September:** deadline for payment of the first 50% of the contracted space, minus the space reservation fee.
- **30 November:** deadline for payment of 100% of the contracted space and services.

Payment can be made through the following methods:

- Transfer to: IFEMA MADRID / FITUR 2027.

Santander: IBAN ES64 0049 2222 5115 1000 1900 SWIFT: BSCHESMM  
 BBVA: IBAN ES89 0182 2370 4000 1429 1351 SWIFT: BBVAESMM  
 Caixa Bank: IBAN ES93 2100 2220 1102 0020 2452 SWIFT: CAIXESBBXXX  
**Send a copy of the bank receipt to [customerservice@ifema.es](mailto:customerservice@ifema.es)**

- Certified cheque made out to IFEMA MADRID/FITUR 2027.
- Credit card in a secure environment, accessible after completing the participation application online, or subsequently in the EXPO ZONE. In accordance with current regulations, payments in cash or bearer cheques are not accepted.

(1) For companies based in Spain (excluding the Canary Islands, Ceuta, and Melilla), a 10% VAT will apply, which is not included in the stated price. For companies based outside Spain, this operation is not subject to Spanish VAT. Exhibitors based in the European Union will be liable for VAT, which, if applicable, may be reclaimed in the country where the company is domiciled.

## 3.1 Solid turnkey stand

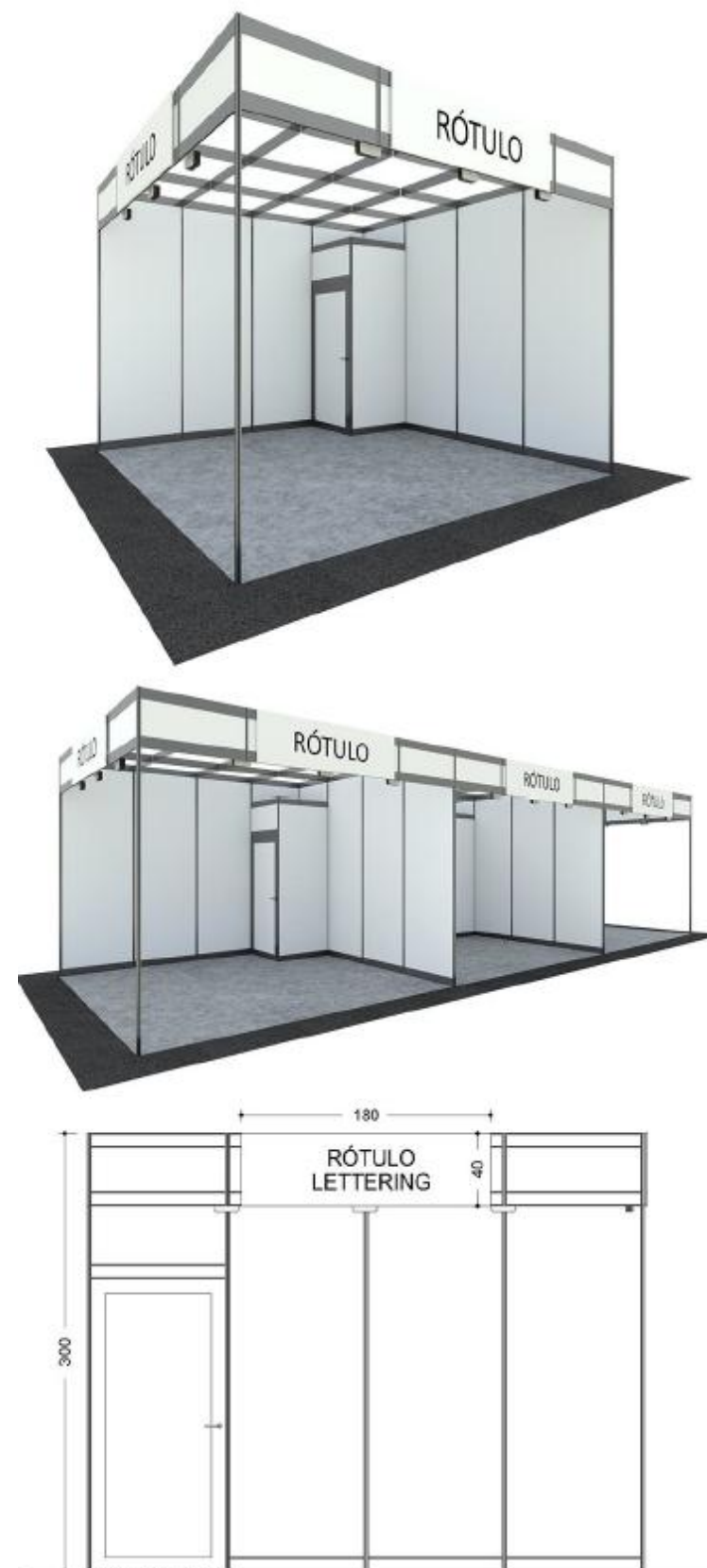

### RATES

"SOLID" turnkey stand (16m<sup>2</sup>): .....€4,498 + VAT (1)  
 Additional m<sup>2</sup> "SOLID" turnkey stand: .....€272.30/m<sup>2</sup>+ VAT (1)

### STAND

Stand opening onto one or more aisles, depending on location.  
 Grey aluminium structure and melamine panels.

### STORAGE ROOM with lockable door approx.:

- For 16 s.q.m .....1x1 s.q.m
- For 16.5 to 32 s.q.m .....2x1 s.q.m
- For 32.5 s.q.m or larger .....3x1 s.q.m

### EXHIBITION CARPETING

5 colors to choose from in Expo Zone. Jasper Gray by default.

Jasper Grey  Red  Black  Leaf green  Blue 

The exhibitor must indicate the chosen carpet color by **December 13, 2026**.

If no color is indicated, jasper gray will be used by default.

### LETTERING:

Standard lettering with name of exhibitor, which is editable in the EXPO ZONE, and stand number. **Maximum 20 characters**. If the exhibitor's name field in the EXPO ZONE is not filled in, it will be labelled with the Trade Fair Name as in the Participation Application Form.

**Important information:** The lettering name must be submitted through your EXPO ZONE before **December 13, 2026**.

### ELECTRICITY AND LIGHTING:

- Lighting by means of LED spotlights on rails at a rate of one spotlight per 3m<sup>2</sup> of stand.
- Electrical panel with magnetothermal differential with a built-in 500W socket, suitable for 130W/m<sup>2</sup> power.

### CLEANING TYPE A:

First cleaning with removal of the plastic covering the carpet, daily cleaning of the floor and collection of the contents of the waste paper bins. Cleaning of the exhibited elements is not included.

### SERVICES INCLUDED

- Daily cleaning of the stand (Type A, once a day)
- Assembly rights included in the price.
- Multi-fair and civil liability insurance included in the price.
- Minimum electric power consumption (0.13 Kw /m<sup>2</sup>)

### MANDATORY CONTRACTING

In addition, participation as an exhibitor implies the obligatory contracting of the EXHIBIOR PLAN CONECTA (formerly the Marketing and Communication pack): €736 + VAT

### ASSEMBLY PLAN

Your assembly plan can be viewed in the EXPO ZONE with the location of the storage room and other services included. In addition, you can track the status of the plan and comment on it, in case you need to make any changes.

### ADDITIONAL SERVICES

Customise your stand with our Stand Graphic Decoration service [decoraciongrafica@ifema.es](mailto:decoraciongrafica@ifema.es)

### FURNITURE

The SOLID turnkey stand **does not include furniture**. Exhibitors may rent it, subject to availability, through the Expo Zone in the SHOP IFEMA MADRID section.

**DRAWING AS A GUIDE.** Drilling and nailing is not permitted. It is permitted to glue with tape, the removal of which does not damage the panels and is subsequently removed. **REMARKS:** • All services or modifications to be introduced from these characteristics shall be at the exhibitor's expense. • The elimination or substitution, by the exhibitor, of any formative element of the modular stand does not imply a reduction in the cost. • The distribution of all the elements that make up the stand, the extras requested, as well as the structural elements necessary for the support of the stand, will be adapted to the needs of the exhibitor, as long as it is technically feasible and the plan with the pertinent indications is received fifteen days before the first day of the beginning of the assembly. Once the stand has been assembled, any changes in the location of all the elements that have not been communicated on the established date will be invoiced. • All the material used, both structural and electrical, is rented and any deterioration will be invoiced according to the current rates. Translated with DeepL.com (free version) • In addition, any exhibitor can hire elements listed in the IFEMA Services Catalogue. • All modular stands that involve interior decoration with panels, profiles, totems, platforms, trusses, etc., must upload their project to the EXPO ZONE before 13 December. - The finished stands will be delivered on **19th January from 8:30 am**.

## 3.2 LIGHT turnkey stand

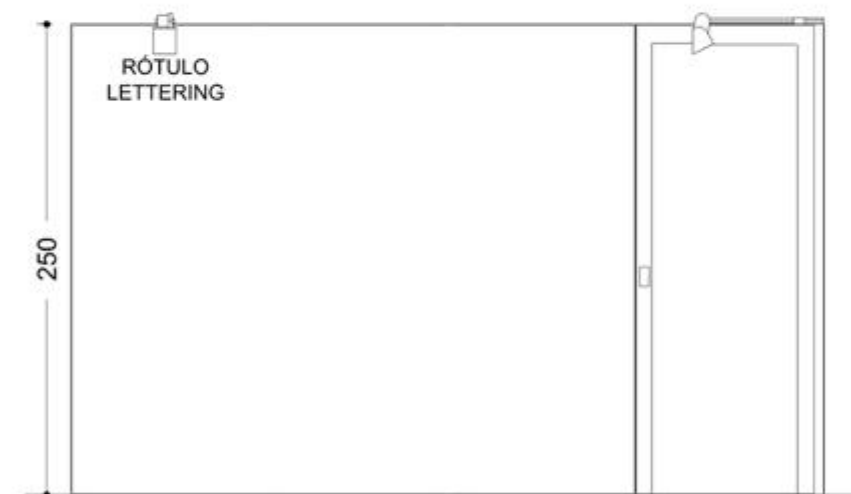

### RATES

"LIGHT" turnkey stand (16m<sup>2</sup>): ..... 5,367 € + VAT  
 Additional m<sup>2</sup> "LIGHT" turnkey stand": .....326.30 €/m<sup>2</sup> + VAT

### STAND

- Stand open to one or more aisles depending on the location plan
- 2.5m high frame structure with white aluminum frame walls.

**STORAGE ROOM** with lockable door with code in the following proportion:

- For 16 s.q.m .....1x1 s.q.m
- For 16.5 to 32 s.q.m .....2x1 s.q.m
- For 32.5 s.q.m or larger .....3x1 s.q.m

### EXHIBITION CARPETING

5 colors to choose from in Expo Zone. Jasper Gray by default.

Jasper Grey  Red  Black  Leaf green  Blue 

The exhibitor must indicate the chosen carpet color by **December 13, 2026**.

### LETTERING:

Standard lettering with name of exhibitor, which is editable in the EXPO ZONE, and stand number. **Maximum 20 characters**. If the exhibitor name field in the EXPO ZONE is not filled in, it will be labelled with the Trade Fair Name on the Participation Application Form.

**Important information:** The lettering name must be submitted through your EXPO ZONE before **December 13, 2026**.

### ELECTRICITY AND LIGHTING:

- Electrical panel at a rate of 130wxm
- 21 led spotlight of 25w x each 4m2
- Double socket base

### CLEANING TYPE A:

First cleaning with removal of the plastic covering the carpet, daily cleaning of the floor and collection of the contents of the waste paper bins. Cleaning of the exhibited elements is not included.

### SERVICES INCLUDED

- Daily cleaning of the stand (Type A, once a day)
- Assembly rights included in the price.
- Multi-fair and civil liability insurance included in the price.
- Minimum electric power consumption (0.13 Kw /m<sup>2</sup>)

### MANDATORY CONTRACTING

In addition, participation as an exhibitor implies the obligatory contracting of the EXHIBITOR PLAN CONECTA (formerly the Marketing and Communication pack): €736 + VAT

### ASSEMBLY PLAN

Your assembly plan can be viewed in the EXPO ZONE with the location of the storage room and other services included. In addition, you can track the status of the plan and comment on it, in case you need to make any changes.

### ADDITIONAL SERVICES

Customise your stand by contacting [standspremium@ifema.es](mailto:standspremium@ifema.es)

### FURNITURE

The LIGHT turnkey stand **does not include furniture**. Exhibitors may rent it, subject to availability, through the Expo Zone in the SHOP IFEMA MADRID section.

**DRAWING AS A GUIDE.** Drilling is not allowed. Nailing or taping is allowed. It shall be adapted to the dimensions of the space allocated.

**REMARKS:** • All services or modifications to be introduced from these characteristics shall be at the exhibitor's expense. • The elimination or substitution, by the exhibitor, of any formative element of the modular stand does not imply a reduction in the cost. • The distribution of all the elements that make up the stand, the extras requested, as well as the structural elements necessary for the support of the stand, will be adapted to the needs of the exhibitor, as long as it is technically feasible and the plan with the pertinent indications is received fifteen days before the first day of the beginning of the assembly. Once the stand has been assembled, any changes in the location of all the elements that have not been communicated on the established date will be invoiced. • All the material used, both structural and electrical, is rented and any deterioration will be invoiced according to the current rates. Translated with DeepL.com (free version) • In addition, any exhibitor can hire elements listed in the IFEMA Services Catalogue. • All modular stands that involve interior decoration with panels, profiles, totems, platforms, trusses, etc., must upload their project to the EXPO ZONE **before 13<sup>th</sup> December**. - The finished stands will be delivered on **19th January from 8:30 am**.

# 3. Types of participation

FITUR

## 3.3 Regulations for turnkey stands

All modular stands with interior decoration with panels, profiles, totems, platforms, trusses, etc., must UPDATE their project in YOUR EXPO ZONE before 13 December 2026.

The removal or replacement by the exhibitor of any element of the modular stand will not qualify for a reduction in price. Any material used, either structural or electrical, shall be subject to rental conditions and any damages shall be invoiced according to the market price.

**The distribution of all the elements that make up the stand, the extras requested, as well as the structural elements necessary for the support of the stand, will be adapted to the needs of the exhibitor, as long as it is technically feasible and the plan with the relevant indications IS UPLOADED TO THE EXPO ZONE no later than one month before the first day of the start of assembly: December 13, 2026**

### CUSTOMISE YOUR STAND WITH US

#### Decoration Services for SOLID turnkey stands

Customise your modular stand with your brand image for maximum visitor impact. We offer you a wide range of graphic materials (vinyl, foam, Forex, tarpaulins, etc.) that are versatile and adaptable to all the elements of your stand (walls, furniture, fronts, banners, displays, etc.). Request more information and a quote. Our specialised team will monitor the production and installation. [decoraciongrafica@ifema.es](mailto:decoraciongrafica@ifema.es)

Once the stand has been set up, changes in location in any elements that have not been communicated by the established date will be invoiced.



(1) Companies based in Spain (excluding the Canary Islands, Ceuta and Melilla): 10% VAT not included. For other companies this operation is not subject to Spanish VAT. For companies based in the European Union, the exhibitor shall be liable to VAT and may, if applicable, claim it back in the country where the company is domiciled.

## 3.4 Space only (Free-design stands)

### RATES

Space only: .....€197.40/m<sup>2</sup> + VAT (1)  
 Double deck:.....€98.70/m<sup>2</sup> + VAT (1)  
 Outdoor space:..... €98.70/m<sup>2</sup> + VAT (1)

Additionally, taking part as an exhibitor entails the mandatory contracting of:

- Liability **insurance** (covers up to €60,000):..... €74.30 + VAT (1)
- Multi-fair **insurance** (covers up to €50,000): .....€70.53 + VAT (1)
- Minimum **electricity consumption** (0.13 kW/m<sup>2</sup>): .....€7.88 + VAT (1)

### • Assembly rights

- ✓ **Type A:** Spaces that are not decorated or fitted with carpeting or flooring: €2.80/m<sup>2</sup> + VAT (1)
- ✓ **Type B:** *Solid* modular stands made of aluminium or similar materials: €5.62/m<sup>2</sup> + VAT (1)
- ✓ **Type C:** Modular stands with aluminium design, carpentry and other materials: €8.94/m<sup>2</sup> + VAT (1)

- **EXHIBITOR PLAN CONECTA** (formerly the Marketing and Communication pack + FITUR Plataforma Digital): €736 + VAT (1)

Companies opting for the free construction of their stands must UPLOAD the project to THEIR EXPO ZONE for approval before **13 December 2026**.

### DESIGN YOUR STAND WITH US

#### Stand design

IFEMA MADRID offers the ideal solution for exhibitors seeking a distinctive presence. Our comprehensive stand design, construction, and assembly service is tailored for those who want a unique and high-impact stand. We take care of the planning of your space, the design, the assembly and disassembly. Request a free, no-obligation project adapted to your needs by sending an email to [standbuilding@ifema.es](mailto:standbuilding@ifema.es)

<https://www.ifema.es/en/fitur/exhibitors/stands-design>

**Normativa de alturas.**  
Máxima ocupación espacial a ocupar con cualquier elemento.

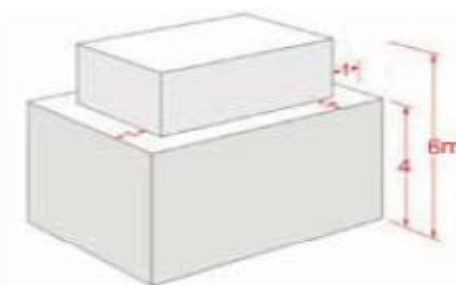

**Cerramientos.**

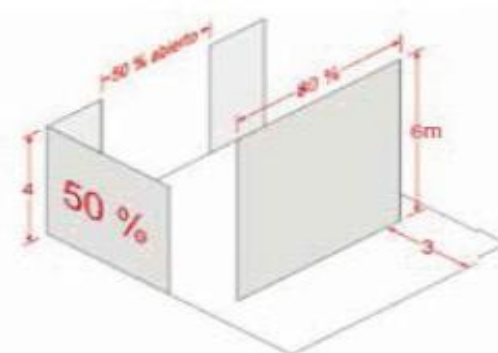

**Segunda planta.**  
Máxima ocupación segunda planta.

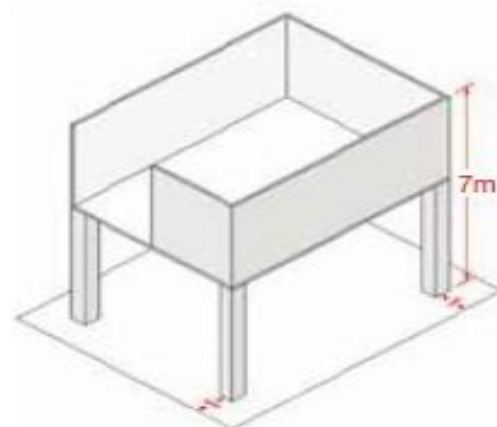

### SPECIFIC ASSEMBLY RULES FOR FREE-DESIGN STANDS

#### Height

- Maximum authorised height within the perimeter line. 4 m
- In order to raise or hang any decorative element to a maximum height of 6 m, a 1 m margin must be left within the inside of the perimeter of the whole stand.
- This possibility does not exist in the connecting nuclei between halls, nor on the entrance sides of Halls 9 and 10.
- Building elements, decoration and spotlights may not protrude more than 50 cm from the allotted space and from a minimum height of 2.5 m.

#### Blind perimeter walls in the perimeter environment

- Blind perimeter walls cannot make up more than 50% of each side facing an aisle.
- Longer walls must be set back at least 3 m from the perimeter and cannot make up more than 80% of the length of the façade.

#### Double Deck

- The maximum permitted height for two-storey stands is 7 m in the halls.
- The second floor must be set back 1 m within the entire perimeter of the stand.
- It is not permitted to build a second floor in the connecting nuclei between the halls and in the side entrance areas to Halls 9 and 10.
- A certificate or a project with its corresponding project management, and signed by a competent technician, must be submitted. This documentation must be endorsed by the corresponding professional association. The certificate or design plan must specify the dimensions, the service load and the capacity, with the exhibitor being completely responsible for complying with the limits set out in the latter.

The interpretation and application of the regulations for each individual case is the responsibility of IFEMA MADRID, which reserves the right to arbitrate on exceptions, if it deems necessary, on the basis of respect for the general appearance of the Fair and the visibility of neighbouring stands.

(1) Companies based in Spain (excluding the Canary Islands, Ceuta and Melilla): 10% VAT not included. For other companies this operation is not subject to Spanish VAT. For companies based in the European Union, the exhibitor shall be liable to VAT and may, if applicable, claim it back in the country where the company is domiciled.

## 3.5 General regulations for assembly. Floor only regulations -Free-design stand.

All companies will be obliged to set up their stand, which includes at least the walls between their stand with the hall wall, and with the adjoining stands, depending on their location.

For **safety** reasons, and as a general and permanent preventive measure due to overlapping activities, **wearing protective helmets, high visibility vests and safety footwear is compulsory during the assembly and dismantling phases of fairs and events in all exhibition areas.**

**No badges are required during assembly**, so there are no passes for assemblers.

No assembly work may begin without the prior completion and submission to IFEMA of the "**Prevention of Labour Risks and Business Activity Coordination**" Protocol available on the IFEMA MADRID website, ifema.es - Exhibitors - Terms and Conditions of Participation - Forms (Article 15 of the General Terms and Conditions of Participation in events organised by IFEMA MADRID).

**Traffic and vehicle parking rules during the event:** Inside the premises of the fair, it is expressly forbidden to keep vehicles parked in loading and unloading areas. Vehicles may only be parked in the areas so designated, paying the corresponding fee, where appropriate. Once the event has begun, no vehicle may be driven inside the halls or on the avenue, unless expressly authorised by IFEMA MADRID (article 14 of the general provisions of the **IFEMA MADRID General Terms and Conditions of Participation**)

**Installation of recyclable carpeting in common areas:** in line with IFEMA MADRID's commitment to the 2030 SDGs (The United Nations' Sustainable Development Goals), as indicated in the [Guide to Sustainable Participation in Fairs and Events](#), and with the aim of optimising the process of installation and removal of recyclable carpeting for subsequent reuse and consequent elimination of the protective plastic at source, the times of entry and exit of merchandise must be adapted to these processes and will be reflected in the corresponding point. Thank you for supporting our environmental commitment.

**Management of assembly and exhibition waste and materials:** all companies participating in the assembly and dismantling of stands at the fair/event must manage, as those directly responsible, the waste they generate so that it can be removed within the established deadlines. IFEMA MADRID will provide you with the possibility of hiring containers to facilitate the selection and removal of waste and will supervise them (see rates in the EXPO ZONE Customer Portal, in Hiring Services, section on cleaning and waste containers).

The exhibitor shall forfeit any right to claim for loss or damage to materials still remaining in the hall exhibition areas after the deadline and shall bear the costs related to their removal, which shall be invoiced by IFEMA MADRID in accordance with the established rates ([see art. 35 of the terms and conditions for exhibitors' participation in events organised by IFEMA MADRID](#)).

### ASSEMBLY OF FREE-DESIGN STANDS

Companies opting for the free construction of their stands must **UPLOAD the project to THEIR EXPO ZONE** for approval **before 13 December 2026**.

**If your project has a rigging structure, you should fill the [Application for hanging structures / rigging in your Expo Zone \(SHOP IFEMA MADRID\)](#) before 13 December 2026.**

The company responsible for assembling the stand must pay IFEMA MADRID the corresponding assembly rights before starting the work. These rights cover the services provided during the assembly and dismantling periods of the Fair. If you, as an exhibitor, wish to pay for these assembly rights and have them included in your invoice, you must contract them through the EXPO ZONE.

### SPECIAL AUTHORISATIONS

On [www.ifema.es](http://www.ifema.es), you will find a list of other services, regulations and forms that may be of interest to you:

- Catering on stands notification.
- Prevention of labour risks and business activity coordination.
- Request for authorisation for private surveillance of stands.
- Authorisation request for Wi-Fi Installation.
- Authorisation request for antenna cable connections.

- Authorisation request for rigging structures.

<https://www.ifema.es/en/support/exhibitors-ifema-fairgrounds>

### AISLE STRIP WITHOUT CARPETING

IFEMA MADRID carpets the aisles throughout the fair and, for reasons of sustainability, does so with reusable strips of standard sizes and, as a consequence, leaves a small strip around the edges of the aisle/s bordering the stands without carpeting. These non-carpeted strips are part of the aisle and do not form part of the stands and therefore the exhibitor is not allowed to cover or decorate them. We request the exhibitor's cooperation in respecting this decision; IFEMA MADRID staff will monitor compliance as far as possible, and will demand the removal of any carpeting that invades these carpet-free strips and, if, despite the controls, the strip is invaded, the invaded aisle space will be invoiced to the exhibitor as additional space.

### ASSEMBLY FEES

In order to be more efficient and to be able to provide you with a better service, we will apply a last minute surcharge to the hiring of assembly rights from **6 January 2027**, as is the case with the rest of our services.

This surcharge increases the price by 25% when the booking is made during the week prior (7 days before) to the start of the assembly, during the assembly, celebration and disassembly.

We would like to remind you that the assembly fees apply to free design assemblies and that they can be contracted with a 5% discount if the contract is made up to 30 days before the start of the fair assembly (15 December 2026).

To contract services, you must go through our online channel, which you can access from the following link: [Commerce](#).

# 4. Exhibitor badges, transport discount vouchers, visas and invitations

## 4.1. Exhibitor badges

Exhibitor badge will be **managed in the EXPO ZONE**, in the section Event Access/Exhibitor Passes.

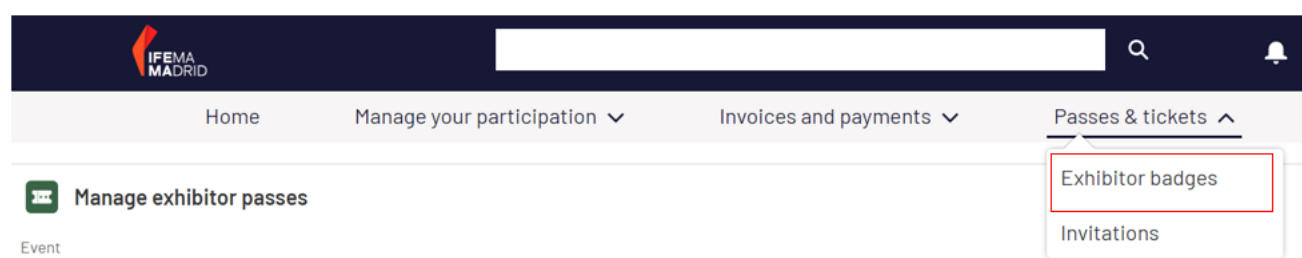

Each exhibitor will be allocated badges based on the contracted surface area:

Contracted area	No. of exhibitor badges
Up to 24.5 m <sup>2</sup> .....	7
From 25 to 49.5 m <sup>2</sup> .....	15
From 50 to 99.5 m <sup>2</sup> .....	18
From 100 to 249.5 m <sup>2</sup> .....	28
From 250 to 499.5 m <sup>2</sup> .....	40
From 500 to 749,5 m <sup>2</sup> .....	75
From 750 to 999.5 m <sup>2</sup> .....	85
1,000 m <sup>2</sup> or more.....	120

This policy does not apply to exchange contracts, where it will be governed by the terms of the established agreement.

To maintain the professional nature of the fair, all exhibitor and co-exhibitor passes will be customised, including the name of the pass holder, company, and country. To prevent misuse, identity checks may be conducted at the entrances to FITUR.

Access controls will be in place during the first three days to ensure the fair remains exclusively professional.

Exhibitors may **purchase additional exhibitor badges for 1 day at €21.60 + VAT (1) or permanent badges at €32.50 + VAT (1) via the EXPO ZONE** section Event Access/Exhibitor Passes.

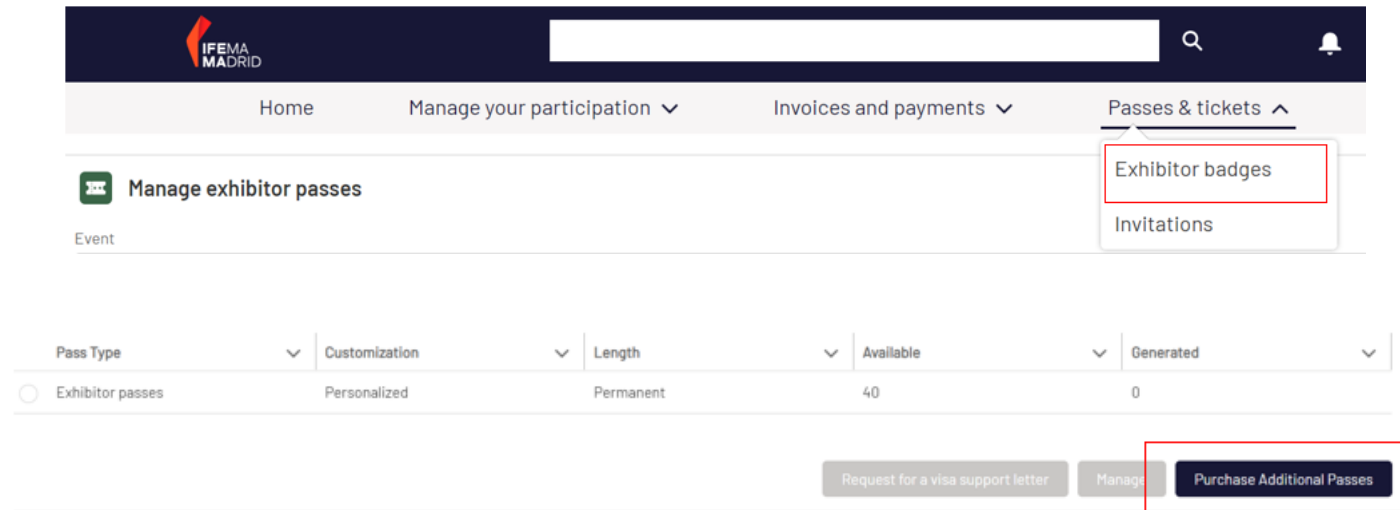

## 4.2. Transport discount vouchers

Once the exhibitor passes have been requested, the **corresponding transport discount vouchers can be downloaded from the EXPO ZONE** in the section Manage your participation/Documents.

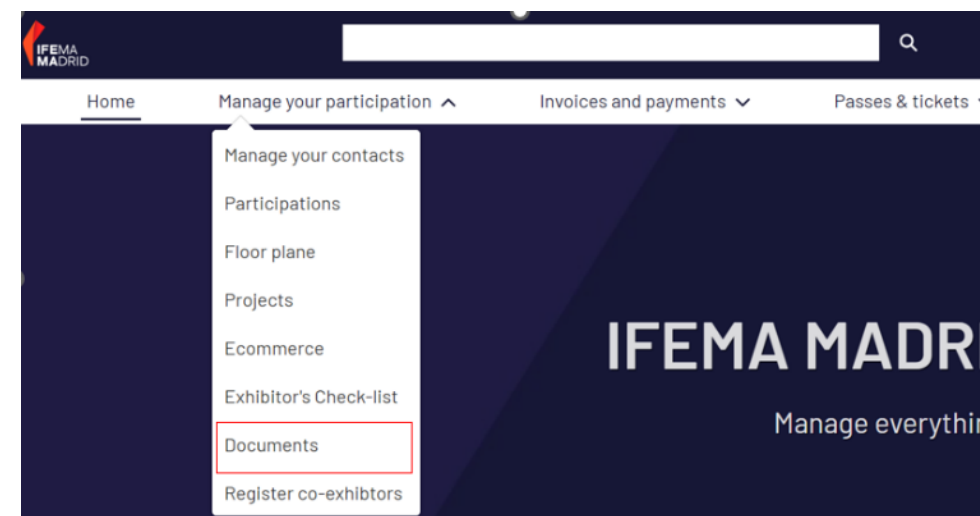

## 4.3. Visa management

If you require a travel visa, you can **request a supporting letter to assist with the application process via the EXPO ZONE**. To do so, **you must first personalise your exhibitor badge and make the payment for your participation** in accordance with the payment schedule (see point 2.2).

Once these two requirements are met, you will be able to access the Request Visa Support Letter button in the EXPO ZONE under Event Access/Exhibitor Passes.

Application deadline for visa support letter: **15th January 2027**

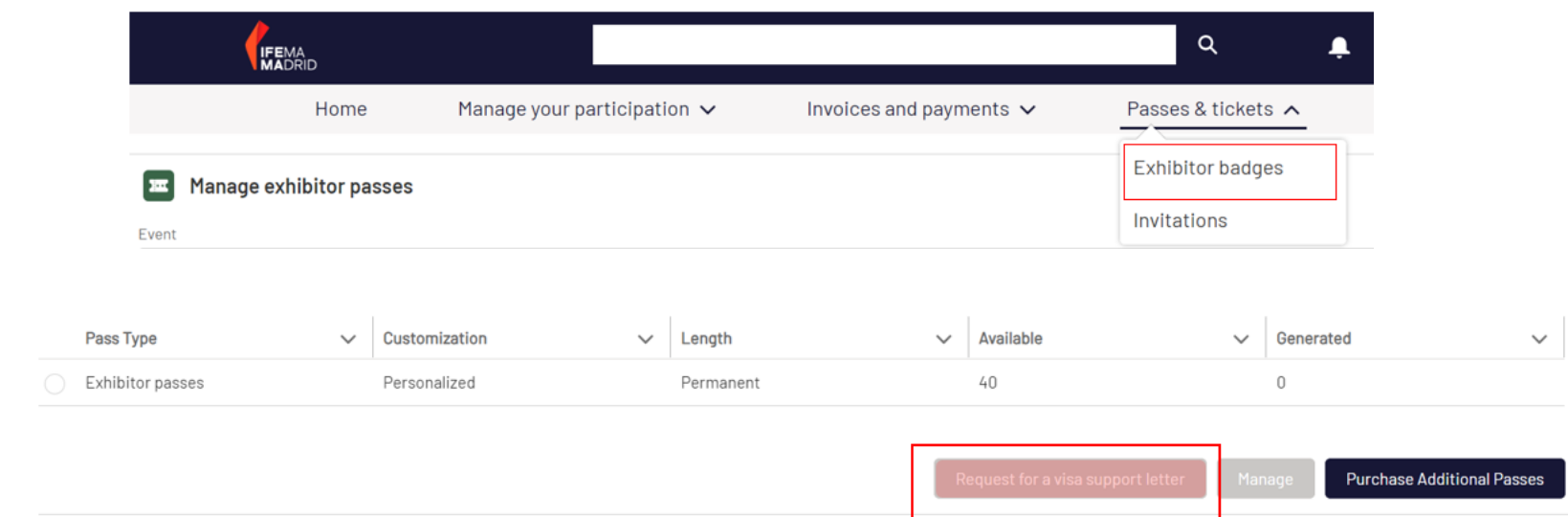

# 4. Exhibitor badges, transport discount vouchers, visas and invitations

## 4.4. Invitations

Each exhibitor will be provided with permanent, one-day, and weekend invitations, depending on the surface contracted.

SURFACE AREA	TRADE INVITATIONS		PUBLIC WEEKEND INVITATIONS
	1 DAY	PERMANENT	
Up to 24.5 m <sup>2</sup>	15	10	25
From 25 to 99.5 m <sup>2</sup>	30	20	50
From 100 to 249.5 m <sup>2</sup>	45	30	75
From 250 to 499.5 m <sup>2</sup>	60	40	100
From 500 to 999.5 m <sup>2</sup>	75	50	125
1,000 m <sup>2</sup> or more <sup>2</sup>	90	60	150

Exhibitors may purchase additional invitations by sending an email to the event requesting the exact number and type of invitations required:

TYPE OF INVITATION	RATE
1-day trade invitation.....	€10.90 + VAT (1)
Permanent trade invitation.....	€19.50 + VAT (1)
Weekend invitation .....	€5.50+ VAT (1)

No refunds will be given for any additional invitations purchased.

Invitations will be sent via the EXPO ZONE/Event access/Invitations/Manage invitations. Once the type of invitation to be issued has been selected (permanent, 1 day or weekend public) the Manage Invitations button will appear.

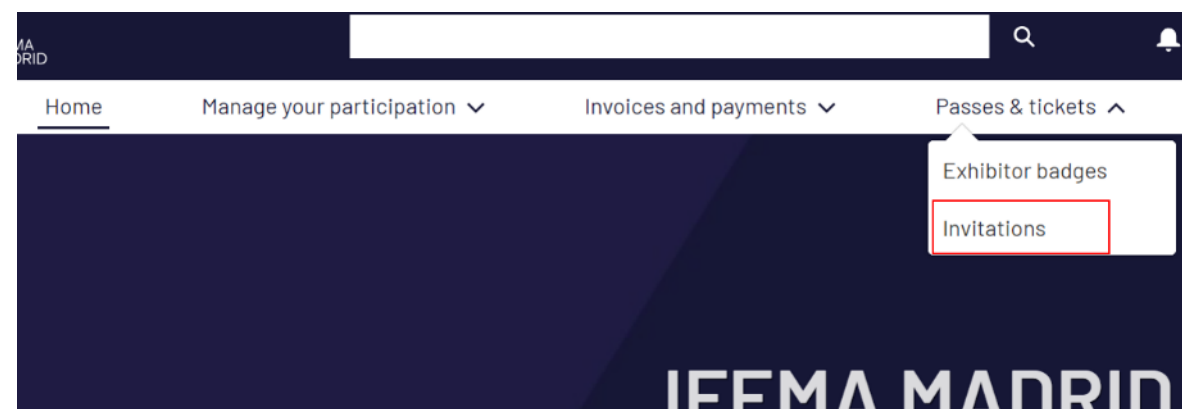

Once this button is clicked, the following screen will appear for you to customise the sending:

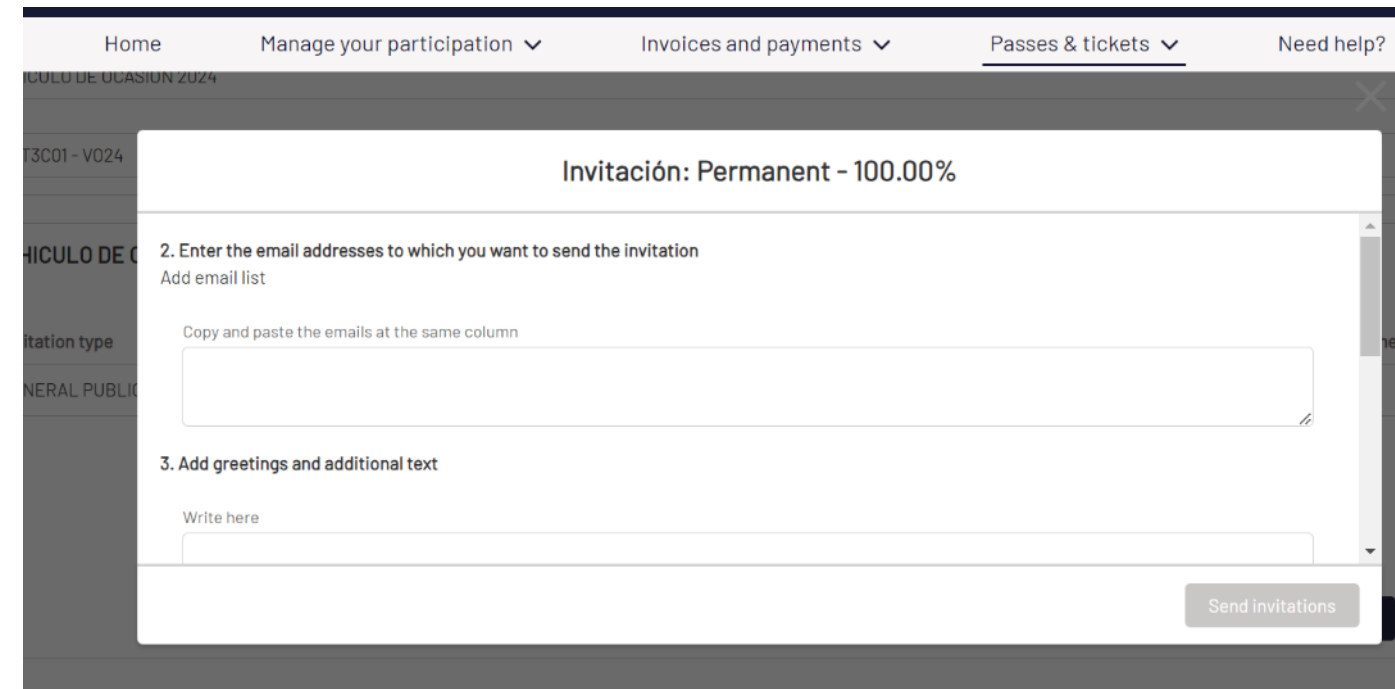

Those who receive the **invitation code must register ONLINE** through the FITUR website ifema.es/fitur in the section Purchase your pass/Buy your ticket, depending on whether the invitation is for trade visitors or the general public respectively, and entering the invitation code received to obtain their free pass to access the fair. (Invitation codes cannot be redeemed at the reception desk.

On the first three days of the fair, which are exclusively for professionals, children under the age of 18 are not allowed to access the exhibition.

(1) Companies based in Spain (excluding the Canary Islands, Ceuta and Melilla): 10% VAT not included. For other companies this operation is not subject to Spanish VAT. For companies based in the European Union, the exhibitor shall be liable to VAT and may, if applicable, claim it back in the country where the company is domiciled.



# 5. Specific terms and conditions of participation

## 5.1. Specific terms and conditions of participation

**5.1.1** The submission of the Participation Application implies full acceptance of IFEMA MADRID's General terms and conditions of Participation, the Specific rules of FITUR 2027 contained in this guide and the technical annexes to the aforementioned regulations, which are available at all times on the IFEMA MADRID website, [ifema.es](http://ifema.es), in the exhibitor information area and on the event website [ifema.es/fitur](http://ifema.es/fitur).

**5.1.2.** Certification. In order to be able to take part in the fair, it is absolutely essential that the activity of the company, public or private body, be encompassed within the industries covered by FITUR.

**5.1.3.** The **minimum** stand area for exhibition is **16m<sup>2</sup>**.

**5.1.4.** Participation as an exhibitor with a stand entails the compulsory contracting of:

- ✓ EXHIBITOR PLAN CONECTA
- ✓ Liability insurance for each assigned stand.
- ✓ Multi-fair insurance for each assigned stand.
- ✓ Minimum electricity consumption.

In the case of booking a floor-space-only stand (free-design stand), the company in charge of assembling the stand must pay IFEMA MADRID, before beginning said work, the corresponding assembly rights fees for the services it provides during the set-up and dismantling periods of the Trade Fair (see point 2).

In the event that, as an exhibitor, you wish to assume the payment of this fee and have it included in your invoice, you must book it in your EXPO ZONE.

**5.1.5.** Fair management may alter the allocated spaces or make changes to the layout of the halls for organisational reasons.

**5.1.6.** Without prejudice to FITUR management informing exhibitors in the event of relocation or significant alteration of the reserved location, each exhibitor is obliged to inform themselves of their stand location, its exact dimensions, etc.

**5.1.7.** Any exhibitor who has not paid the full fee for the space booked as well as any costs for services requested, shall not be permitted to either occupy the stand space or have the modular stand delivered.

**5.1.8.** The exhibitor must not leave their stand unattended and must remain with the products on display throughout the entire period and opening hours of the exhibition. Non-compliance with this regulation could mean losing the right to preferential renewal of the allocated space.

**5.1.9.** Exhibitors authorise IFEMA MADRID to reproduce all or part of their stand and the products, services and activities carried out therein.

**5.1.10.** The exhibitor undertakes to comply with the rules and guidelines for protecting the environment.

**5.1.11. Musical performances and performances by folk groups are totally forbidden during FITUR on professional days. No musical instruments may therefore be brought into the premises on these days. Performances may, however, be held at the exhibitor's stand on Saturday 23 and Sunday 24, January 2027.**

**5.1.12. It is strictly prohibited to use individual sound systems which are audible beyond the strict boundaries of the stand or which may be a nuisance to visitors or other exhibitors. The maximum authorised noise level is 60 decibels. Breaches of this rule will lead to the automatic cut-off of the fair's electrical supply and may lead to the subsequent loss of preferential renewal rights to the allocated space. Additionally, on days for professionals, special care must be taken when distributing promotional items that might cause unnecessary noise.**



# 5. Specific terms and conditions of participation

**5.1.13.** Promotional activities, the distribution and display of samples, leaflets, brochures, flyers and all kinds of promotional material will only be carried out within each exhibitor's space. In order to avoid conflicts, exhibitors and co-exhibitors participating in FITUR may not display any kind of advertising on their stands or on the IFEMA MADRID site, in any kind of format (brochures, videos, photographs, symbols, etc.), relating either directly or indirectly to territories in which there is a territorial dispute, unresolved at the time of FITUR, with other countries at the fair. Failure to comply with this rule may lead to the withdrawal of the aforementioned advertising by the FITUR Organisers.

Professional activities and seminars (exhibitors and co-exhibitors authorised by their host exhibitor only) performed within the Exhibition Centre must be reported to FITUR Management. To organise press conferences, please contact: Press and Communication Management [premsa@ifema.es](mailto:premsa@ifema.es)

For room rental, please check availability: [uanproduccion@ifema.es](mailto:uanproduccion@ifema.es)

**5.1.14.** Activities requiring the booking of a one-off catering service during FITUR will require the completion of the "[Communication form for catering on stands](#)" available at [ifema.es](mailto:ifema.es), which should be sent to: [catering@ifema.es](mailto:catering@ifema.es)

**5.1.15.** The contracting of any service, as well as the carrying out of any activity by a co-exhibiting company, must necessarily have prior written authorisation from the company owning the stand, which will also be responsible for any possible expenses that its co-exhibitors may generate as a result of their participation in the fair if they do not pay for them.

**5.1.16.** Visitors who cannot be accredited as belonging to the participating trade groups are not allowed access to the exhibition on trade days. This applies to both exhibitors and visitors, even if they have the corresponding pass or invitation.

**5.1.17.** Exhibitors taking part in FITUR as part of a concession or exchange cannot include co-exhibiting companies in their stands, in accordance with the IFEMA MADRID General Terms and Conditions of Participation.

**5.1.18.** It is expressly forbidden for Exhibitors to install WI-FI access points, whether for connecting to the INTERNET or for providing other functions. The aim of this measure is to prevent problems with interference, affecting both points that the Exhibitor could install independently and IFEMA MADRID's access points. Said interference could cause the existing WI-FI networks to not work properly. For further information, please consult [Article 33 of the General Rules for Exhibitor Participation in Fairs Organised by IFEMA MADRID](#).

**5.1.19.** For exceptional cases where materials and items must be brought in or taken out while the trade fair is in progress, exhibitors must request an individual permit from Exhibition Services Management: ([customerservice@ifema.es](mailto:customerservice@ifema.es))

**5.1.20** Any external documentation must be subject to internal review and obtain the express approval of IFEMA Madrid; therefore, its processing may involve waiting periods and adjustments, in light of the nature of IFEMA MADRID as a Public Consortium.

**5.1.21** These Specific Rules are complemented by the Terms and Conditions of Participation of Exhibitors in Events Organised by IFEMA MADRID, which all exhibitors accept by virtue of becoming exhibitors.

## 5.2. Co-exhibitor registrations

Co-exhibitors must be registered by the main exhibitor via the EXPO ZONE, under Manage Your Participation > Register Co-Exhibitors.

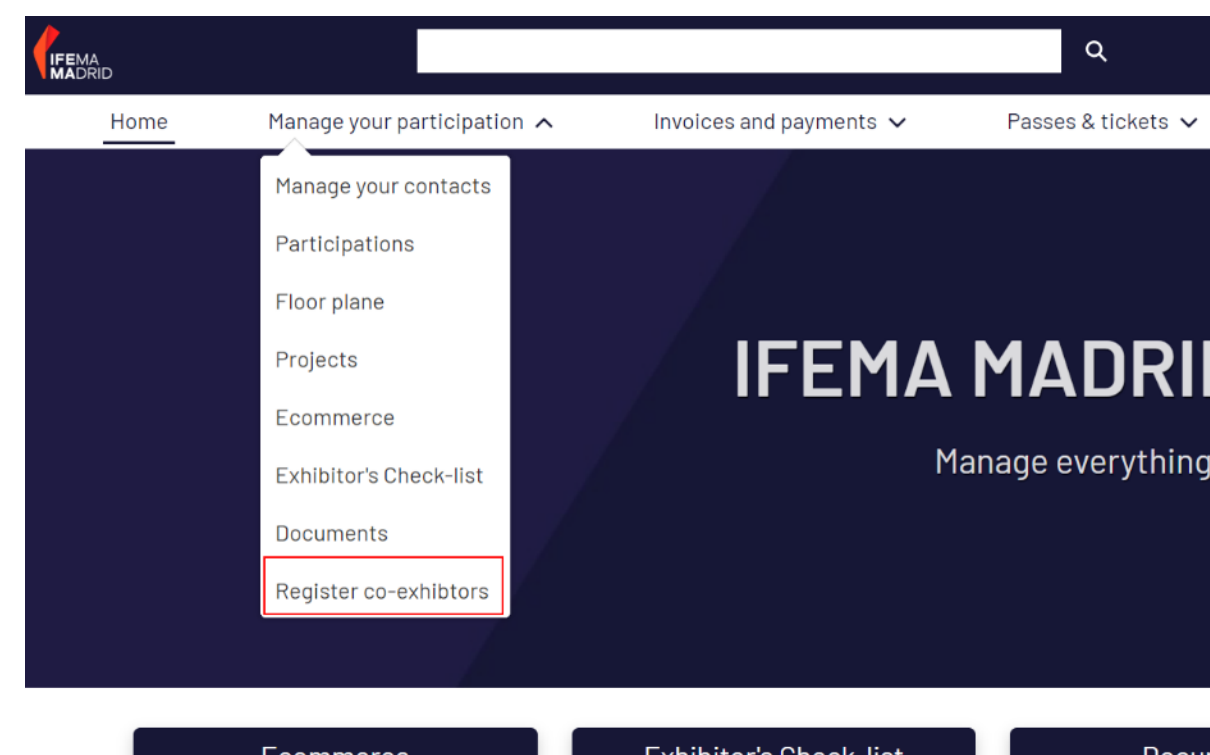

To complete the registration, a valid and unique email address must be provided for each co-exhibitor, along with an indication of whether the participation fee will be paid by the main exhibitor or the co-exhibitor.

**Co-exhibitor registration fee.....€88+ VAT/company (1)  
Registration fee over 50 co-exhibitors ..... €4,400 + VAT (1)**

Once this process has been completed, the co-exhibitor will receive a unique code to be included in their application form\*.

**\*If the exhibitor assumes the cost of participation of the co-exhibitor, their registration will be confirmed by sending the participation application form (mandatory requirement).**

**\*If the co-exhibiting company assumes their own cost of participation, their registration will be confirmed by sending the participation application form and paying the corresponding amount.**

Each registered co-exhibitor will benefit from:

**CO-EXHIBITOR EXHIBITOR PLAN CONECTA** which includes:

- Access to FITUR Plataforma Digital, the largest professional network for the tourism industry.
- Presence in the online exhibitor catalogue. Visibility in the official list of exhibitors accessible at: [ifema.es/fitur](http://ifema.es/fitur)
- Access to their own EXPO ZONE.
- 2 Exhibitor badges.

**The co-exhibitor must manage their 2 exhibitor passes in the EXPO ZONE**, in the section Event Access/Exhibitor Passes.

The co-exhibitor will be able to purchase additional exhibitor passes at the SOUTH Entrance reception desk at the IFEMA MADRID trade fair centre.

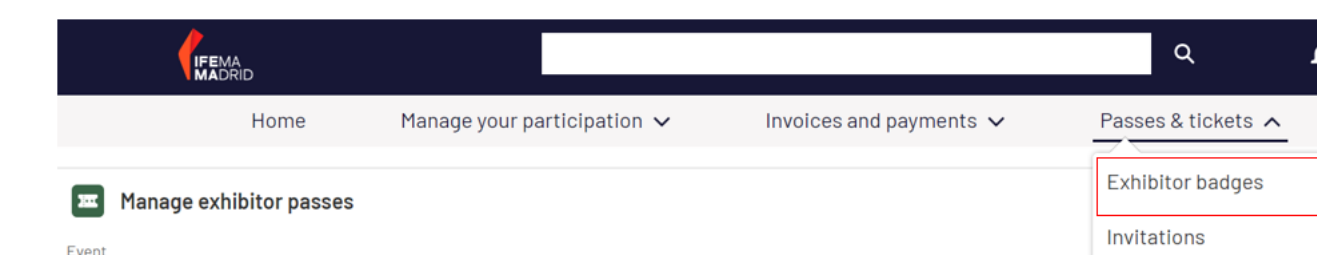

(1) Companies based in Spain (excluding the Canary Islands, Ceuta and Melilla): 10% VAT not included. For other companies this operation is not subject to Spanish VAT. For companies based in the European Union, the exhibitor shall be liable to VAT and may, if applicable, claim it back in the country where the company is domiciled.

## 1. SET-UP DATES AND TIMES

### NEW SCHEDULE

#### Assembly of free-design stands:

- Halls 1,2,3,4,5,6,7,8,9 and 10
  - ✓ 13,14,15 and 18 January from **6.30 am to 9.30 pm.**
  - ✓ 16 and 17 January from **6.30 am to 7.30 pm.**
- Hall 12
  - ✓ 16 and 17 January from **6.30 am to 7.30pm**
  - ✓ 18 January from **6.30 am to 9.30 pm**

Any exhibitor who has not paid the full fee for the space booked as well as any costs for services requested, shall not be permitted to either occupy the stand space or have the modular stand delivered.

The **delivery of modular stands** booked with IFEMA MADRID will take place on **19 January from 8.30am.**

### NEW SCHEDULE

**Delivery of incoming merchandise and decoration material** can be carried out on **19 January from 6.30 am to 9.30pm. From 7.00pm onwards, entry will only be possible through the pedestrian gates**, as the goods entrances will be closed to proceed with the installation of recyclable carpeting.

For incidents with Exhibitor Badges, registration desks will be set up at the South Entrance and North Entrance from 18 to 24 January from 9.30am to 7.00pm. Only issues related to Exhibitor and Co-Exhibitor Passes will be dealt with.

#### Celebration of FITUR 2027

- ✓ From 20 to 22 January Trade Visitors only: from 10.00am to 7.00pm.
- ✓ From 23 and 24 January Trade Visitors and General Public: opening hours, 23 January from 10.00am to 8.00pm and 24 January from 10.00am to 6.00pm.
- ✓ Hall 12, open from 20 to 22 January from 10.00h to 19.00h.

Exhibitors may enter the premises from 8.00am and leave one hour after closing time.

#### Removal of goods and decorative materials:

This may take place on **24 January, from 6:30 pm to 12:00 pm . From 6:00 pm to 6:30 pm**, it will only be possible to exit through the pedestrian doors to remove recyclable carpeting.

**In Hall 12**, the removal of goods and decorative materials **will be open on 22 January from 7.30 p.m. to midnight.** From 7.00 p.m. to 7.30 p.m., exit will only be possible through the pedestrian gates.

#### Dismantling of stands :

- Halls 1,2,3,4,5,6,7,8,9 and 10
  - ✓ 25 and 26 January from 6.30 am to 9.30 pm
  - ✓ 27 January from 6.30 am to 3.00 pm
- Hall 12
  - ✓ 23 and 24 January from 6.30 am to 9.30 pm

## DELIVERY OF MERCHANDISE TO THE TRADE FAIR CENTRE. CUSTOMS REGULATIONS

### 2.

1. All products coming from non-EU countries must go through customs procedures, with special mention to the fact that, since 1 January 2020, the United Kingdom has been treated as a third country, so all shipments originating from the United Kingdom must regularise their merchandise through the corresponding customs procedure.

2. Exhibiting companies must have the details of the customs agent clearing their goods or, failing this, a copy of the customs documentation for entry into the European Union.

3. The material or merchandise for distribution or consumption is subject to Spanish taxes, even if they are products with no commercial value (depending on the country, the amount of taxes may vary).
4. All goods subject to a temporary regime must not be moved from the stand or leave the IFEMA MADRID trade fair centre until their situation has changed and customs formalities have been completed. It may only be deposited during these formalities in the warehouse of the official logistics agent within the trade fair centre.
5. It is strictly forbidden to sell or distribute non-Community goods at a trade fair before customs clearance has been completed.
6. Products transported as hand luggage must be declared at Barajas Airport in the RED CHANNEL ("Something to declare") and the goods must be cleared with the corresponding authority at the airport.
7. Goods that have not passed customs control and are on display will be confiscated by the customs authorities operating at the Trade Fair Centre until the appropriate documents are presented.
8. Any lorry arriving at IFEMA MADRID under a transit consigned to IFEMA MADRID, must go to the warehouse of the official Logistics Operator, for the regularisation of the transported goods, located at:

Avenida Partenón sn  
Entrada Oeste - access on Calle Rivera del Sena  
Pabellón de servicios nave 2  
28042 Madrid

**To avoid any issues and for any inquiries, please contact our official Customs Logistics Operator, DSV, at (+34) 91 722 3000 or via email at : [es.sha.ifema.madrid@dsv.com](mailto:es.sha.ifema.madrid@dsv.com)**

# 7. Exhibition Floor Plan

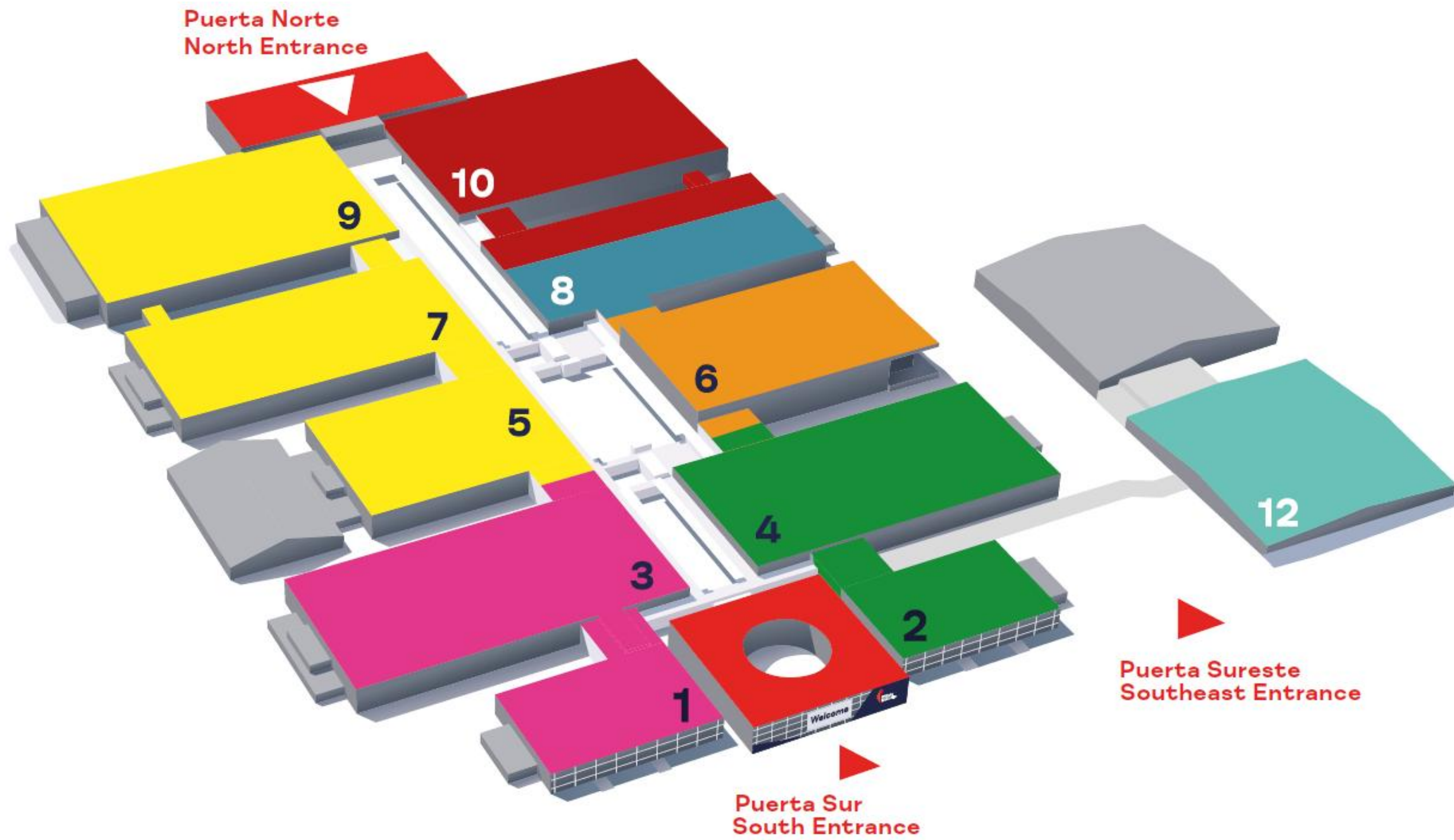

## PABELLÓN / HALL 1

**AMÉRICA**  
THE AMERICAS

## PABELLÓN / HALL 3

**AMÉRICA**  
THE AMERICAS

## PABELLÓN / HALL 5

**ENTIDADES Y ORGANISMOS OFICIALES ESPAÑOLES**  
SPANISH OFFICIAL ENTITIES AND ORGANIZATIONS

## PABELLÓN / HALL 7

**ENTIDADES Y ORGANISMOS OFICIALES ESPAÑOLES**  
SPANISH OFFICIAL ENTITIES AND ORGANIZATIONS

## PABELLÓN / HALL 9

**ENTIDADES Y ORGANISMOS OFICIALES ESPAÑOLES**  
SPANISH OFFICIAL ENTITIES AND ORGANIZATIONS  
<Fitur> <LGBT+>

## PABELLÓN / HALL 12 PABELLÓN DEL CONOCIMIENTO / KNOWLEDGE HUB

**TRAVEL TECHNOLOGY**

<Fitur> <Experience> <Fitur> <Sports> <Fitur> <TechY>  
<Fitur> <Know-how & Export> <Fitur> <Talent>

## PABELLÓN / HALL 2

**EUROPA**  
EUROPE  
<Fitur> <Lingua> <Fitur> <Women>  
<Fitur> <4aI>

## PABELLÓN / HALL 4

**EUROPA**  
EUROPE  
<Fitur> <Cruises> <Fitur> <Screen>

## PABELLÓN / HALL 6

**ÁFRICA + EGIPTO**  
AFRICA + EGYPT

## PABELLÓN / HALL 8

**EMPRESAS**  
COMPANIES  
**ASIA-PACÍFICO / ORIENTE MEDIO**  
ASIA-PACIFIC / MIDDLE EAST

## PABELLÓN / HALL 10

**EMPRESAS**  
COMPANIES

# 8. Additional services of IFEMA MADRID

## Interested in building your stand with us?

### For exhibitors who have contracted floor space only

IFEMA MADRID offers the ideal solution for exhibitors seeking a distinctive presence. Our comprehensive stand design, construction, and assembly service is tailored for those who want a unique and high-impact stand. From space planning and design to assembly and dismantling, our in-house team will support you every step of the way, ensuring regulatory compliance, optimal resource use, and a flawless execution.

Why choose IFEMA MADRID's stand-building service?

- ✓ Exclusive designs aligned with your brand identity
- ✓ Efficient execution by a dedicated professional team
- ✓ Guaranteed quality and on-time delivery

Request your personalized, no-obligation proposal by emailing: [standbuilding@ifema.es](mailto:standbuilding@ifema.es)

### I WANT TO LEARN MORE

## Graphic decoration for modular stands

### For exhibitors who want to customise their stand

The service includes the management of your stand decoration project from the initial definition to the installation. You can customise your modular stand with our **Stand Graphic Decoration service**:

- **Solid turnkey stand:** [decoraciongraficaifema.es](http://decoraciongraficaifema.es)
- **Light turnkey Stand:** [standpremium@ifema.es](mailto:standpremium@ifema.es)

We offer a wide range of materials to install on your stand: foam, phorex, vinyl, canvas, and other alternatives that fit with different types of formats. We install on walls or on furniture such as counters, showcases or others.

You can hire services and furniture from the IFEMA MADRID Services Catalogue, or find more information in Zona Expo.

## Outdoor and Digital Advertising

### Advertising projects adapted to your needs

- Promote your brand before, during and after the event.
- Attract new customers through the best B2B segmentations in the market.

### MORE INFORMATION

## Other services of interest

On the fair website [ifema.es/fitur](http://ifema.es/fitur) you will find a list of other services, regulations and documents that may be of interest to you

- Communication for catering at stands.
- Occupational risk prevention and coordination of business activities.
- Application for authorisation for private security at stands.
- Application for authorisation to install Wi-Fi.
- Application for authorisation for antenna cabling.
- Application for authorisation to hang structures/ rigging.



# 8. Complementary services of IFEMA MADRID

FITUR

		Phone	Email
<b>Promote your brand</b>			
<b>Advertising at the venue and in digital channel</b>	Boost the presence of your brand and products at the trade fair. Our Advertising team will advise you on the best physical and digital supports to generate the greatest impact.	(+34) 91 722 53 40 (+34) 91 722 53 08	<a href="mailto:publicidadexterior@ifema.es">publicidadexterior@ifema.es</a>
<b>Graphic decoration for <i>solid</i> turnkey stands</b>	Customize your modular stand with your brand image. Our team of Advisors will help you define what best suits your stand and will follow up on production and installation. You will have everything ready for when you arrive	(+34) 91 722 57 22	<a href="mailto:decoraciongrafica@ifema.es">decoraciongrafica@ifema.es</a>
<b>Stand design and construction</b>	Do you need a spectacular stand design adapted to your budget? Our partner companies have extensive experience in the exhibition sector and IFEMA MADRID guarantees the quality of their designs and assemblies. Contact us without commitment	(+34) 91 722 57 22	<i>Solid</i> turnkey stand: <a href="mailto:decoraciongraficaifema.es">decoraciongraficaifema.es</a> <i>Light</i> turnkey Stand: <a href="mailto:standspremium@ifema.es">standspremium@ifema.es</a>
<b>Sponsorships</b>	Tailor-made sponsorship solutions aligned with your brand's objectives.	(+34) 91 722 30 00	<a href="mailto:patrocinios@ifema.es">patrocinios@ifema.es</a>
<b>Organize and decorate your space</b>			
<b>Furniture</b>	Make your space a place of work and relationship with your clients. Tables, offices, sofas, counters, everything adapted to your style and budget	(+34) 91 722 30 00	<a href="mailto:customerservice@ifema.es">customerservice@ifema.es</a>
<b>Cold and kitchen equipment</b>	Solutions for food preservation and hospitality for all the activities you want to organize in your stand	(+34) 91 722 30 00	<a href="mailto:equiposdefrioycocina@ifema.es">equiposdefrioycocina@ifema.es</a>
<b>Telecommunications and IT</b>	We have the latest technology in equipment and connectivity to cover all communication needs.	(+34) 91 722 30 00	<a href="mailto:telecomunicaciones@ifema.es">telecomunicaciones@ifema.es</a>
<b>Auxiliar Staff</b>	We offer you from auxiliary staff to help you with the set up to hostesses during the celebration, who will help you to attend your clients in different languages and with the utmost professionalism.	(+34) 91 722 30 00	<a href="mailto:customerservice@ifema.es">customerservice@ifema.es</a>

# 8. Complementary services of IFEMA MADRID

FITUR

		Phone	Email
<b>Organize and decorate your space</b>			
<b>Cleaning and waste containers</b>	Audiovisuals and sustainability are primary concerns for IFEMA MADRID. To this end, we provide exhibitors and assemblers with various types of cleaning services and a complete waste management system that complies with all environmental and health and safety standards and regulations	(+34) 91 722 30 00	<a href="mailto:customerservice@ifema.es">customerservice@ifema.es</a>
<b>Audiovisuals</b>	We have the best equipment for multimedia presentations, sound and translation in stands and rooms.	(+34) 91 722 30 00	<a href="mailto:customerservice@ifema.es">customerservice@ifema.es</a>
<b>Booking Conditions</b>			
<b>Transport and storage</b>	Sending, receiving and storing the merchandise you need for your participation is very easy at IFEMA MADRID. We offer a complete or partial service, national or international, always adapted to your needs.	(+34) 91 722 30 00	<a href="mailto:customerservice@ifema.es">customerservice@ifema.es</a>
<b>Driverless cherrypickers and lifters</b>	If you need to unload merchandise or use special machinery to display your product, we have a wide range of driverless cherrypickers, forklifts and lifters to complete any task.	(+34) 91 722 30 00	<a href="mailto:carretillasdealquiler@ifema.es">carretillasdealquiler@ifema.es</a>
<b>Last Minute Contracting</b>			
<b>E-commerce: Last minute Services Catalogue</b>	Now, during the assembly and celebration you can also hire online the services you need. Without the need to go anywhere, just with your access codes	(+34) 91 722 30 00	<a href="mailto:customerservice@ifema.es">customerservice@ifema.es</a>

# 9. Important dates

FITUR

When	What	How	Who attends to you
<b>Until 5 June 2026</b>	Application for participation (Priority deadline for FITUR 2026 exhibitors)	<ul style="list-style-type: none"> <li>• Sending the application form for exhibitors of FITUR 2026, to confirm the renewal of their space, and surface area or to request a change.</li> <li>• Filling in the application form online and send a copy of the space reservation payment to: <a href="mailto:customerservice@ifema.es">customerservice@ifema.es</a></li> </ul>	Event management: <b><a href="mailto:fiturexpositor@ifema.es">fiturexpositor@ifema.es</a></b> Customer Service (Exhibitors): (+34) 91 722 30 00 <b><a href="mailto:customerservice@ifema.es">customerservice@ifema.es</a></b>
<b>From 5 June</b>	Application for participation	<ul style="list-style-type: none"> <li>• Continuation of the process of receiving applications for participation for FITUR 2026 exhibitors.</li> <li>• Proposals, confirmation of space and sending of contracts</li> </ul>	Event management: <b><a href="mailto:fiturexpositor@ifema.es">fiturexpositor@ifema.es</a></b> Customer Service (Exhibitors): (+34) 91 722 30 00 <b><a href="mailto:customerservice@ifema.es">customerservice@ifema.es</a></b>
<b>Until 14 September 2026</b> <b>Until 30 November 2026</b>	Payments	<ul style="list-style-type: none"> <li>• Until 14 September - 50% of the amount of the space minus the reservation fee.</li> <li>• Until 30 November - 100% of the amount of the space and services booked.</li> </ul>	Servifema: <b><a href="mailto:customerservice@ifema.es">customerservice@ifema.es</a></b> (+34) 91 722 30 00

# 9. Important dates

When	What	How	Who attends to you
<b>Until 13 December 2026</b>	Free-design projects	Deadline for uploading free-design projects to the EXPO ZONE. If the project has hanging elements they need be submitted in a separate project and sent to: <a href="mailto:rigging@ifema.es">rigging@ifema.es</a>	Technical Office IFEMA MADRID Line Exhibitors (+34) 91 722 30 00 <a href="mailto:customerservice@ifema.es">customerservice@ifema.es</a>
	Customisation of modular stands	<ul style="list-style-type: none"> <li>• Present projects for interior decoration of modular stands.</li> <li>• Choose wall and carpet colours (Floor + Solid Stand) in Expo Zone.</li> <li>• Notify signage in the EXPO ZONE.</li> <li>• The modular stand project must be notified in the EXPO ZONE, or uploaded with the stipulated modifications before 6 January.</li> </ul>	Technical Office IFEMA MADRID Line Exhibitors (+34) 91 722 30 00 <a href="mailto:customerservice@ifema.es">customerservice@ifema.es</a>
<b>Until 15 December 2026</b>	Booking services	Services booked with a 5% discount.	IFEMA MADRID Line Exhibitors (+34) 91 722 30 00 <a href="mailto:customerservice@ifema.es">customerservice@ifema.es</a>
<b>From 6 January 2027</b>	Booking services	25% increase on prices for last minute contracting of assembly rights and all other services.	IFEMA MADRID Line Exhibitors (+34) 91 722 30 00 <a href="mailto:customerservice@ifema.es">customerservice@ifema.es</a>
<b>From 13 to 19 January 2027</b>	Stand set-up	<ul style="list-style-type: none"> <li>• Halls 1,2,3,4,5,6,7,8,9, and 10: -On 13,14,15 and 18 January from <b>6.30 am</b> to 9.30 pm. -16th and 17th January from <b>6.30 am</b> to 7.30pm.</li> <li>• Hall 12: -16 and 17 January from <b>6.30 am</b> to 7.30 pm. -18th January from <b>6.30 am</b> to 9.30 pm.</li> </ul>	Technical Office IFEMA MADRID Line Exhibitors (+34) 91 722 30 00 <a href="mailto:customerservice@ifema.es">customerservice@ifema.es</a>

# 9. Important dates

FITUR

When	What	How	Who attends to you
<b>19 January 2027</b>	Delivery of modular stands	<ul style="list-style-type: none"> <li>• From 8.30 am</li> <li>• The incoming merchandise and decoration material may take place on 19 January</li> </ul>	Hall manager (Located at the main entrance of each Hall)
	Incoming merchandise	<ul style="list-style-type: none"> <li>• From <b>6.30 am</b> to 9.30 pm</li> <li>• From 7.00 pm onwards, entry will only be possible through the pedestrian gates, as the goods entrances will be closed in order to proceed with the installation of recyclable carpeting.</li> </ul>	Hall manager (Located at the main entrance of each Hall)
<b>From 20 to 24 January 2027</b>	Days of the trade fair	<ul style="list-style-type: none"> <li>• From 20 to 22 January Trade Visitors only: from 10.00 am to 7.00 pm.</li> <li>• 23 and 24 January Trade Visitors and General Public: opening hours, 23 January from 10.00 am to 8.00 pm and 24 January from 10.00 am to 6.00 pm.</li> <li>• Hall 12, Knowledge Hall only from 20 to 22 from 10:00 am to 7:00 pm.</li> </ul>	-
<b>24 January 2027</b>	Outgoing merchandise	<ul style="list-style-type: none"> <li>• From 24 January at 6.30 pm to 0.00 am. From 6.00 pm to 6.30 pm, exit will only be possible through the pedestrian gates in order to proceed with the removal of recyclable carpeting.</li> <li>• Hall 12: Exit of goods and decoration material will be open on 22 January from 7.30 pm to midnight. From 7.00 pm to 7.30 pm, exit will only be possible through the pedestrian gates.</li> </ul>	Hall manager (Located at the main entrance of each Hall)
<b>From 26 to 28 January 2026</b>	Dismantling of stands	<ul style="list-style-type: none"> <li>• Halls 1,2,3,4,5,6,7,8,9 and 10: -25 and 26 January from 6.30 am to 9.30 pm. -On 27 January from 6.30 am to 3 pm.</li> <li>• Hall 12: -23th and 24th January from 6.30 am to 7.30 pm</li> </ul>	Hall manager (Located at the main entrance of each Hall)

# 10. Sustainability Culture Management at IFEMA MADRID

FITUR

At IFEMA MADRID we are not only fully committed to sustainability per se, but also to achieving the sustainable development goals (hereinafter SDGs) promoted by the United Nations, which we have incorporated into our strategic corporate management policy and culture

IFEMA MADRID's sustainability policy is mainly focused on the following SDGs: 8, 9, 11, 12, 13, 16 and 17.

**IFEMA MADRID'S sustainability policy is mainly based on the following SDGs: Nos. 8, 9, 11, 12, 13, 16 and 17.**

ISO Standards certified by IFEMA MADRID:

- ISO 9001: Quality Management,
- ISO 20121: Event Sustainability Management.
- ISO 14001: Environmental Management,
- ISO 50001: Energy Management,
- ISO 22320: Emergencies Management.
- ISO 27001: Information Security Management.

**ACTIONS TAKEN AT IFEMA MADRID TO REDUCE GAS EMISSIONS AND BE MORE ENERGY EFFICIENT:**

- 100% certified electrical energy of renewable origin.
- Geothermal installation in Puerta Sur building.
- Low consumption lighting in our halls and on our modular stands.
- Controlling the temperature of our air-conditioning / HVAC systems.

IFEMA MADRID is in possession of "calculo" (I calculate) and "reduzco" (I reduce) stamps in Carbon Footprint Scopes 1 and 2.

## **WASTE MANAGEMENT:**

• The exhibitor/assembler is the generator of the waste and shall therefore be responsible for its removal and management. How the waste generated by the exhibitor is managed is explained in article 35 of the General Rules of Participation.

• We offer our exhibitors a service that includes the removal and management of the waste they/their assemblers generate. (check our fees in Exhibitors' Area).

## **Carpet recycling:**

IFEMA MADRID recycles 100% of the carpeting used in aisles and communal areas. To do so it has been essential to change our assembly and disassembly process, that affects the entry and removal of goods (check the corresponding item) . Furthermore, means that it has to be laid in strips instead of covering the entire surface area as was previously the case. This means we can guarantee its conversion into a new raw material for the subsequent manufacture of other products.

## **SUSTAINABLE MOBILITY:**

IFEMA MADRID offers access to public transport close to its facilities (metro and bus), parking for electric cars with 100% renewable electricity charge points, as well as a parking area for bicycles and scooters

## **GUIDE TO SUSTAINABLE PARTICIPATION IN TRADE FAIRS/EVENTS:**

IFEMA MADRID has published its Guide to Sustainable Participation in Trade Fairs for exhibitors on its website. We recommend you read it before starting to prepare your participation:

[ifema.es/en/about-us/quality-sustainability](https://ifema.es/en/about-us/quality-sustainability)



Question	Answer
<p><b>Where can I consult the IFEMA MADRID General Rules of Participation to which my participation is subject?</b></p>	<p>In addition to the Exhibitor's Guide, participation in Fitur is subject to IFEMA MADRID's General Rules of Participation, which you should be informed about and which you can access on the IFEMA MADRID website (<a href="http://www.ifema.es">www.ifema.es</a>) and via the following link <a href="#">IFEMA MADRID General Rules of Participation</a>.</p>
<p><b>Can I hire a catering service or serve my own food and beverages at the stand?</b></p>	<p>Yes. Exhibitors who are going to offer a catering service at their stand (free of charge), can do so either by submitting their application with the approved catering companies at IFEMA MADRID (See the list <a href="#">HERE</a>) or through other catering service providers, in which case it is essential to fill in the form "<a href="#">Notification for the provision of catering services on stands</a>" available in the exhibitors' area of the institutional website and send it, with the information requested therein, to: <a href="mailto:catering@ifema.es">catering@ifema.es</a> for its information and appropriate ends. If IFEMA MADRID has not been notified, the Exhibitor will not be able to offer this service on their stand. The Exhibitor assumes responsibility for third-party complaints that are caused by said catering service, and expressly exempts IFEMA from any liability in this regard.</p> <p>Parking for catering vehicles and refrigerated lorries: There is a parking area for catering vehicles and refrigerated lorries, which can be electrically connected. This can be booked via <a href="#">eCommerce</a></p>
<p><b>Can I access the trade fair centre with vehicles for assembly and disassembly or loading and unloading of goods?</b></p>	<p>Access to IFEMA MADRID and to the inside of the halls will be done through the doors and on the days and times stated in this Exhibitor's Guide. The inside of Halls will only be accessed to unload materials. Vehicles will not be able to park inside the halls or in the adjacent areas. We would like to remind you that, for safety reasons, it is strictly forbidden to park directly in front of the goods entrance.</p> <p>IFEMA MADRID takes no responsibility for the surveillance of vehicles while they are on the grounds of Feria de Madrid.</p> <p>There is a car park for trucks and another for private cars, which can be used by paying, where appropriate, the corresponding fees. <a href="#">Check rates</a></p>
<p><b>Can I have a vehicle on my stand?</b></p>	<p>Vehicles with a combustion engine used as part of an exhibition display must have a tank filled with the minimum fuel required to access the allocated space and be able to leave it at the end of the exhibition.</p>

Question	Answer
<p><b>Can I send goods to my booth?</b></p>	<p>IFEMA MADRID staff are not authorised to receive merchandise for your stand. In order to send merchandise to the venue, the exhibitor must indicate the delivery address: IFEMA MADRID (Avda. del Partenón, 5. 28042 Madrid. Spain). FITUR Trade Fair Name of your company. Hall and stand number.</p> <p>The merchandise must be received by your company's staff at your stand and arrive on the days set aside for incoming merchandise and decoration. If it is not possible to comply with the above, we recommend that you contact your freight forwarding partner: DSV office at the IFEMA Trade Fair Centre MADRID. Hall 7 <a href="mailto:es.sha.ifema.madrid@dsv.com">es.sha.ifema.madrid@dsv.com</a></p>
<p><b>Can I have musical or folklore performances at FITUR?</b></p>	<p>Musical and folk group performances are strictly forbidden during the days FITUR is open to trade only. Musical performances may only take place on stands on Saturday 25 and Sunday 26 January 2026.</p> <p>It is strictly prohibited to use individual sound systems which are audible beyond the strict boundaries of the stand or which may be a nuisance to visitors or other exhibitors. The maximum authorised noise level is 60 decibels.</p>
<p><b>What procedure do I have to follow to hang structures in the halls/rigging?</b></p>	<p>Exhibiting companies may hang elements from the ceiling of the halls following the procedure shown in the "<a href="#">Regulations for hanging structures in Halls</a>" and by completing the form "Application for authorisation for hanging structures/rigging" and sending it to: <a href="mailto:rigging@ifema.es">rigging@ifema.es</a></p>
<p><b>Can I hold prize draws and raffles at the stand?</b></p>	<p>Raffles, prize draws, and random combination games are forms of gambling as set out in articles 3.2 and defined in article 15 of Law 6/2001 of 3 July on gambling in the Community of Madrid.</p> <p>All the information is available in the following form: <a href="https://sede.comunidad.madrid/comunicaciones-declaraciones/cifras-tombolas">https://sede.comunidad.madrid/comunicaciones-declaraciones/cifras-tombolas</a></p>
<p><b>How do I apply for a visa support letter?</b></p>	<p>Visa support letters are managed through the EXPO ZONE. To do so, you first have to personalise your exhibitor passes. Once you have managed your exhibitor passes, you can request your support letters and download them to your computer.</p> <p>It is essential to be up to date with payments according to the payment schedule in order to be able to apply for the letters.</p>

Question	Answer
<p><b>What kind of passes and invitations are available at Fitur?</b></p>	<p><b>Exhibitor Passes:</b> are allocated according to the m<sup>2</sup> booked. They can be personalised at the EXPO ZONE and additional permanent and one-day passes can also be purchased.</p> <p><b>Invitations:</b> are allocated according to the m<sup>2</sup> booked. Each exhibitor will be able to send online trade-only and general public invitations to their contacts through the EXPO ZONE. With these invitations they can register online and get their free passes for direct access to the fair.</p>
<p><b>Where can I book the services for my stand?</b></p>	<p>Either through the SHOP IFEMA MADRID section inside the EXPO ZONE or via the link: <a href="https://shop.ifema.es">https://shop.ifema.es</a></p>
<p><b>Who do I contact to book a room?</b></p>	<p>Exhibitors who need to book a room should contact with: <a href="mailto:uanproduccion@ifema.es">uanproduccion@ifema.es</a></p>
<p><b>What does the CONECTA EXHIBITOR PLAN include?</b></p>	<p>This compulsory contracting concept includes the following services:</p> <ul style="list-style-type: none"> <li>• Dissemination of the participation in the fair through insertion in the list of exhibitors accessible in open access on the fair's website and shared in communications.</li> <li>• Presence during the fair on the hall plans and lists of exhibitors on display.</li> <li>• Presence as exhibitors in the digital event of the fair with a maximum of 60 products or services associated with the company file.</li> <li>• Access to IFEMA MADRID's 'ZONA EXPO' customer portal to manage participation.</li> <li>• Exhibitor passes according to the contract (see point 2.3).</li> <li>• Online invitations according to the contract (see point 2.3) and delivery service through the EXPO ZONE.</li> <li>• Discount vouchers for transport.</li> <li>• Premium Wi-Fi connection for 3 users during the whole fair (5 GHz devices).</li> <li>• Access codes will be sent the days before the fair starts.</li> <li>• Access to the digital event for unlimited users with connection functionalities to generate business opportunities.</li> </ul>

Question	Answer
<p><b>How to use the EXPO ZONE?</b></p>	<p>The following video shows a tutorial on the use of the EXPO ZONE <a href="https://youtu.be/14ujh4uPKTA">https://youtu.be/14ujh4uPKTA</a></p>
<p><b>What are the benefits of my ExpoZone?</b></p>	<p>Used to manage the participation of each exhibiting company in FITUR.</p> <ul style="list-style-type: none"> <li>• Registration of contacts who are going to access the Expo Zone and management of access permissions.</li> <li>• Access to the exhibitor's calendar.</li> <li>• View documents of interest.</li> <li>• Manage exhibitor passes, request visa support letters and send invitations.</li> <li>• Register co-exhibitors.</li> <li>• View or download payments, statement of accounts and invoices issued.</li> <li>• Upload free design stand projects and distribution of modular stand elements.</li> <li>• Add the sign and choose the colour of the carpet for exhibitors with modular stands.</li> <li>• Access the e-commerce for contracting services.</li> <li>• Access the digital platform to manage the catalogue and networking.</li> </ul>
<p><b>What are the features of my Digital Platform?</b></p>	<p>In my company area:</p> <ul style="list-style-type: none"> <li>• Update the company data visible in the catalogue and in the digital event.</li> <li>• Show the range of products and services on offer.</li> <li>• Manage the company's appointment schedule for professional meetings at the stand.</li> <li>• Register other team members on the platform.</li> </ul> <p>At the digital event:</p> <ul style="list-style-type: none"> <li>• Complete my personal profile on the platform and my agenda of availability for meetings.</li> <li>• Search for contacts of interest in the professional network and request and accept to be a contact for chat and videoconferences.</li> <li>• Manage meeting requests</li> <li>• Scan trade visitor badges at the fair.</li> <li>• View information on the offer of other exhibitors.</li> <li>• Consult the activities with the possibility of scheduling them and viewing the digital content available.</li> </ul>

Question	Answer
<p><b>How can I request my invoices?</b></p>	<p>Invoices are not generated by default. You must request them directly from the IFEMA MADRID invoicing department (<a href="mailto:customerservice@ifema.es">customerservice@ifema.es</a>) indicating the event at which you are exhibiting and the items to be included in the invoice. Once it has been generated, it will be available in your EXPO ZONE.</p>
<p><b>What is the difference between space only, LIGHT turnkey stand and SOLID turnkey stand?</b></p>	<p>The space-only system only includes the booking of the stand space and the mandatory elements (insurance, minimum electricity consumption, assembly fee and Communication and Marketing Pack + Live Connect), and it is down to the exhibitor to create a free-design stand or hire it through the stand <a href="#">design service offered by IFEMA MADRID</a>.</p> <p>The modular stands available (Solid and Light) are delivered assembled. The Solid stand is made of aluminium and melamine panels, while the Light stand is made of modular frames, with a height of 2.5m. You can see the detailed characteristics on page 5 and 6 under point 3.</p>
<p><b>Can I decorate and/or set up my stand with IFEMA?</b></p>	<p>Yes, IFEMA MADRID offers two main services:</p> <ul style="list-style-type: none"> <li>• <b>Graphic decoration for stands:</b> <ul style="list-style-type: none"> <li>-<b>Solid Stand :</b> Customise your modular stand with the image of your brand, generating maximum impact on visitors. There is a wide range of versatile graphic materials that can be adapted to walls, furniture, fronts, banners, etc. You can request information and a quote at <a href="mailto:decoraciongrafica@ifema.es">decoraciongrafica@ifema.es</a>.</li> <li>-<b>Light Stand :</b> Design a premium stand fully customised with the visual identity of your brand and achieve a memorable impact on your visitors. We have a wide variety of versatile graphic materials that adapt perfectly to walls, furniture, fronts, banners and much more. For more information and a no-obligation quote, please visit: <a href="mailto:standpremium@ifema.es">standpremium@ifema.es</a></li> </ul> </li> <li>• <b>Stand design:</b> this is a comprehensive stand design service fully tailored to your needs. From the planning of your space, design, assembly and disassembly. You can request information and a quote at <a href="mailto:standbuilding@ifema.es">standbuilding@ifema.es</a></li> </ul>
<p><b>Is it compulsory to be present on the stand over the weekend?</b></p>	<p>Yes, exhibitors must not leave their stand unattended and must remain with the products on display throughout the entire period and opening hours of the event. Exhibitors in <b>Hall 12</b> can leave the stand at the weekend, as the hall will only be open on trade days from 20-22 January.</p>

Question	Answer
<p><b>Are assembler's passes necessary during the set-up of the trade fair?</b></p>	<p>No. The requirements to be able to access the build-up are to have paid 100% of their participation fee, to have the project submitted and approved, to have paid the build-up rights, and to have completed the occupational risk prevention protocol.</p>
<p><b>How can I book parking at IFEMA?</b></p>	<p>Exhibiting companies will be able to book parking spaces through the e-commerce section inside the EXPO ZONE (SHOP IFEMA MADRID) or via the link <a href="https://shop.ifema.es">https://shop.ifema.es</a> Once the contract has been signed, parking badges can be collected from two days prior to the start of the fair at the exhibitor services desk, located in the central boulevard between halls 6 and 8.</p>
<p><b>What coverage do I have as an exhibitor with the insurance included in the <i>solid</i> and <i>light</i> packs?</b></p>	<p>You can check the coverage of the compulsory insurance policies at the <a href="#">IFEMA MADRID exhibitor support area</a>.</p>
<p><b>How can I access the WI-FI network as an exhibitor?</b></p>	<p>As an exhibitor you will receive as part of the EXHIBITOR PLAN CONECTA a Wi-Fi connection for 3 users during the entire trade fair for the exclusive use of stand holders. Devices that allow 5GHz network capability are required. Access codes will be sent out during the lead up to the event.</p> <p>Additional Wi-Fi access can be booked through the e-commerce section inside the EXPO ZONE or via the link <a href="https://shop.ifema.es">https://shop.ifema.es</a></p>
<p><b>Regulations and support for exhibitors at the trade fair center</b></p>	<p><a href="https://www.ifema.es/en/support/exhibitors-ifema-fairgrounds">https://www.ifema.es/en/support/exhibitors-ifema-fairgrounds</a></p>
<p><b>Regulations and support for fitters at the trade fair center:</b></p>	<p><a href="https://www.ifema.es/en/support/assemblers-colaborators-fairgrounds">https://www.ifema.es/en/support/assemblers-colaborators-fairgrounds</a></p>

Department	Ask me about	Contact							
<b>Address of the event</b>	<ul style="list-style-type: none"> <li>Contracting space</li> <li>General topics of participation in the fair</li> <li>Exhibitor passes</li> <li>Trade visitor invitations</li> <li>Activities and forums at the fair</li> </ul>	<table border="1"> <tr> <td><b>Director</b></td> <td>María Valcarce</td> <td rowspan="3">                     (+34) 91 722 30 00  <a href="mailto:futurexpositor@ifema.es">futurexpositor@ifema.es</a> </td> </tr> <tr> <td><b>Managers</b></td> <td> <b>National and Company:</b> David Solar  <b>International:</b> <ul style="list-style-type: none"> <li>Ángela Lozano: Europe and the Americas</li> <li>José Sánchez: Africa, Asia-Pacific, Middle East and Travel Technology</li> <li>Ainhoa de la Cruz</li> </ul> </td> </tr> <tr> <td><b>Commercial Area</b></td> <td>Ana Isabel Prieto Ana Sánchez Macarena Ferrer</td> </tr> </table>	<b>Director</b>	María Valcarce	(+34) 91 722 30 00 <a href="mailto:futurexpositor@ifema.es">futurexpositor@ifema.es</a>	<b>Managers</b>	<b>National and Company:</b> David Solar <b>International:</b> <ul style="list-style-type: none"> <li>Ángela Lozano: Europe and the Americas</li> <li>José Sánchez: Africa, Asia-Pacific, Middle East and Travel Technology</li> <li>Ainhoa de la Cruz</li> </ul>	<b>Commercial Area</b>	Ana Isabel Prieto Ana Sánchez Macarena Ferrer
		<b>Director</b>	María Valcarce	(+34) 91 722 30 00 <a href="mailto:futurexpositor@ifema.es">futurexpositor@ifema.es</a>					
		<b>Managers</b>	<b>National and Company:</b> David Solar <b>International:</b> <ul style="list-style-type: none"> <li>Ángela Lozano: Europe and the Americas</li> <li>José Sánchez: Africa, Asia-Pacific, Middle East and Travel Technology</li> <li>Ainhoa de la Cruz</li> </ul>						
<b>Commercial Area</b>	Ana Isabel Prieto Ana Sánchez Macarena Ferrer								
<b>IFEMA MADRID Customer Service</b>	<ul style="list-style-type: none"> <li>Hiring of services</li> <li>Expo Zone</li> <li>Visitor information</li> </ul>	(+34) 91 722 30 00 <a href="mailto:customerservice@ifema.es">customerservice@ifema.es</a>							
<b>Technical Secretariat (Trade Fair Services Department)</b>	<ul style="list-style-type: none"> <li>Technical support to exhibitors and assemblers</li> <li>Review of stand assembly projects</li> <li>Solutions to technical problems during the exhibition activity</li> <li>Customization of modular stands</li> <li>Coordination for stand catering</li> </ul>	(+34) 91 722 30 00 <a href="mailto:customerservice@ifema.es">customerservice@ifema.es</a> <a href="mailto:catering@ifema.es">catering@ifema.es</a>							
<b>Graphic decoration</b>	Hiring of graphic materials to customize your booth	Solid turnkey stand: (+34) 91 722 30 00 <a href="mailto:decoraciongrafica@ifema.es">decoraciongrafica@ifema.es</a> Light turnkey stand: <a href="mailto:standpremium@ifema.es">standpremium@ifema.es</a>							
<b>Full service stand design</b>	Design and assembly of free design stands	(+34) 91 722 30 00 <a href="mailto:standbuilding@ifema.es">standbuilding@ifema.es</a>							

# 12. Contact us

FITUR

Department	Ask me about	Contact
<b>Outdoor Advertising</b>	Hiring of advertising media at the fairgrounds	(+34) 91 722 53 40/08 <a href="mailto:publicidadexterior@ifema.es">publicidadexterior@ifema.es</a>
<b>Communication and Marketing Management</b>	Media relations	<div style="display: flex; justify-content: space-between;"> <div> <b>Director:</b> Raúl Diez  <b>Press Officer:</b> Alejandra Elorza  <b>International Press:</b> Elena Valera  <b>Press Secretary:</b> Pilar Serrano                 </div> <div style="text-align: right;">                     (+34) 91 722 50 93  <a href="mailto:aelorza@ifema.es">aelorza@ifema.es</a> </div> </div>
<b>Planning and Control Management</b>	<ul style="list-style-type: none"> <li>Rental of the different meeting and convention spaces at the fairgrounds, both during and outside the fairs.</li> <li>Coordination of extra-fair activities</li> </ul>	(+34) 91 722 30 00 <a href="mailto:uanproduccion@ifema.es">uanproduccion@ifema.es</a>
<b>Institutional Relations (Protocol)</b>	<ul style="list-style-type: none"> <li>Institutional visits</li> <li>Guided tours</li> <li>Protocol for all Events</li> <li>Institutional relations</li> </ul>	(+34) 91 722 30 00 <a href="mailto:infoifema@ifema.es">infoifema@ifema.es</a>
<b>Safety and Self-Protection Management</b>	<ul style="list-style-type: none"> <li>General security and parking</li> <li>Access to the Fairgrounds</li> </ul>	(+34) 91 722 30 00 <a href="mailto:dseguridad@ifema.es">dseguridad@ifema.es</a>
<b>Medical Service and Security Emergencies</b>	<ul style="list-style-type: none"> <li>Medical emergency</li> <li>Health care for exhibitors and visitors during the celebration of fairs, set-up and dismantling.</li> </ul>	(+34) 91 722 54 00

Thank you

