

Fiaa



International Bus and Coach Trade Fair

22-24
Sep
2026

ifema.es

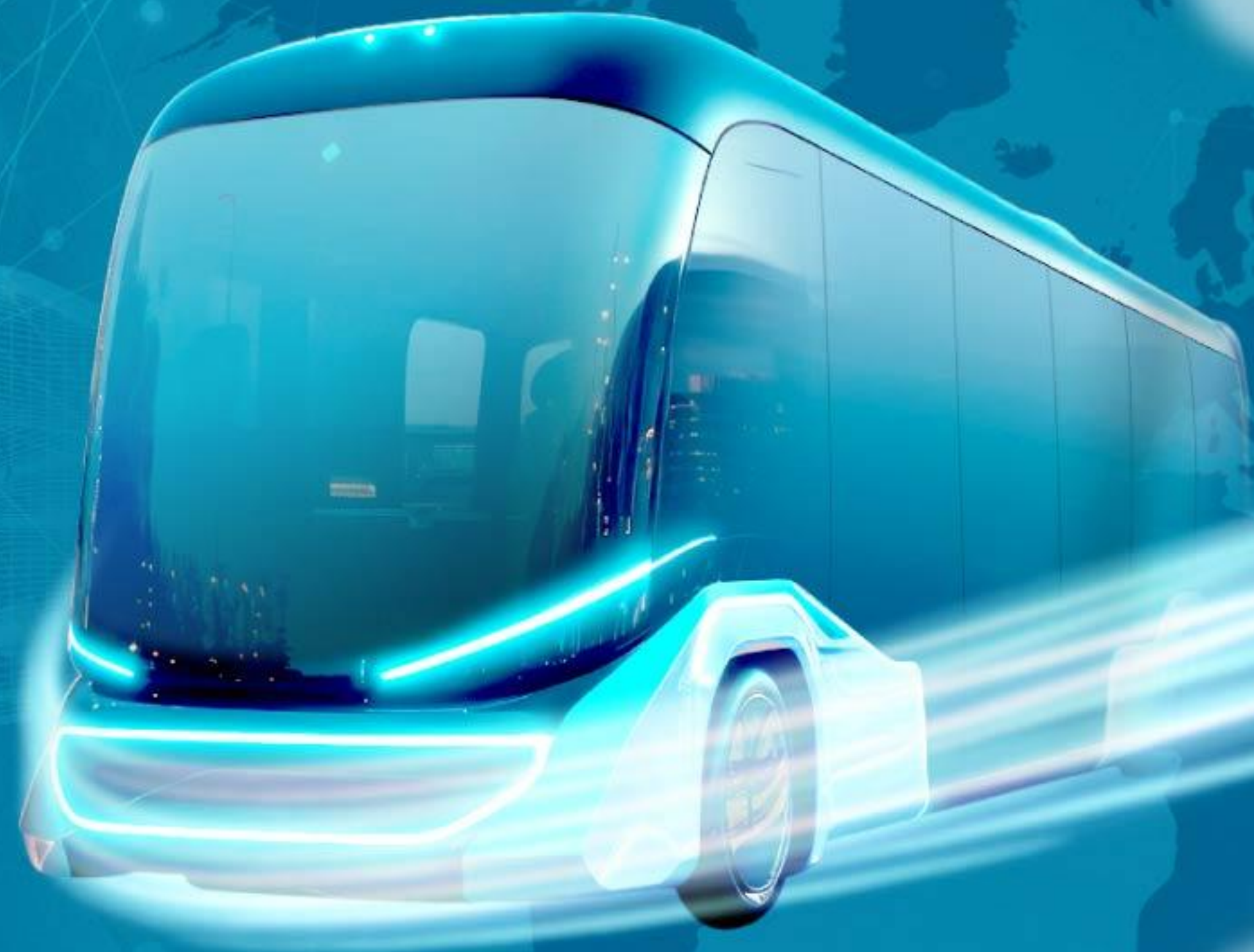

LIVE  Connect
365D IMPACT · CREATE COMMUNITY · GROW

 **IFEMA
MADRID**

INDEX

1. HOW TO PARTICIPATE. SPECIFIC RULES FOR PARTICIPATION

- 1.1 Dates. Timetable. Venue. Sectors convened.
- 1.2 What do I have to do to participate?
- 1.3 Contracting and allocation of spaces.
- 1.4 Participation modalities and exhibition areas.
- 1.5 Your exhibitor plan.
- 1.6 Your space at the fair. Types of stands. Regulations and assembly
- 1.7 Participation fees
- 1.8 Deadlines and forms of payment
- 1.9 Other specific rules of the fair
- 1.10 Exhibitor's calendar

2. MANAGE YOUR PARTICIPATION

- 2.1 Expo Zone. Manage your participation and your space
Contracting additional services. E-commerce
- 2.2 . LIVE Connect: the digital platform to which you have access with your Plan .
- 2.3 Registration of co-exhibitors
- 2.4 Passes and invitations. Visas. Vouchers and discounts
- 2.5 Additional services
- 2.6 Other relevant information.
- 2.7. Site plan.
- 2.8. IFEMA MADRID Services

3. PROMOTE AND MONETISE YOUR PARTICIPATION

- 3.1 How to make my participation profitable
- 3.2 Exhibitor Catalogue
- 3.3 Visitors Guide
- 3.4. Networking
- 3.5. Improve your Exhibitor plan.
- 3.6 Invitations for your customers and contacts
- 3.7 Buyer Programme
- 3.8 Publish your news and novelties. RRSS and WEB
- 3.9 Outdoor and digital advertising
- 3.10 Sponsorships
- 3.11 Special promotional actions
- 3.12 Conferences, demonstrations and seminars at trade fairs.
- 3.13 Innovation Gallery
- 3.14 Hall rental

4. SUSTAINABILITY MANAGEMENT AT IFEMA MADRID

5. FREQUENTLY ASKED QUESTIONS

6. CONTACT US

1. HOW TO PARTICIPATE. SPECIFIC RULES FOR PARTICIPATION

1.1 Dates. Timetable. Venue. Sectors involved

FIAA, the International Bus and Coach Trade Fair, will take place at the IFEMA MADRID exhibition centre from **22nd to 24th September 2026** from **10:00 a.m. to 19:00 p.m.**

Exhibitors will be able to enter the exhibition centre from 8:30 a.m. and leave before 7:30 p.m. On Tuesday 22 September, during the press day, exhibitors will be able to enter at 8:00 a.m. and accredited press at 8:30 a.m.

The virtual event via the LIVE Connect digital platform will be open from 1 June to 30 November 2026.

The character of the fair is professional.

Complete Vehicles:

1. Chassis
2. BodyworkComponents, Accessories and Technology
3. Maintenance and After Sales
4. Transport Infrastructures
5. Sustainable Mobility and Alternative Energies
6. Other Professional Services and Solutions
7. Associations, Organisations and Institutional Services
8. Technical Press and Specialist Media

1.2 What do I have to do to participate?

The application to participate starts by filling in, within the established deadline, the online **Participation Application form** accessible from **the fair's website**.

This form will allow us to inform you in the most complete way and make you a proposal for participation. You can check the booking and payment deadlines on the form itself and in the Exhibitor's Calendar.

The presentation of the Application to Participate implies full acceptance of **the General Rules of Participation in Exhibitions organised by IFEMA MADRID**, the technical annexes, the Specific Rules of this edition and any generic or specific provisions established by the fair organisers.

The exhibitor company is the company that will participate in the fair, in whose name the application to participate as an exhibitor is completed.

In order to apply to participate in the fair, the exhibitor's activity, whether it is a company, public or private organisation, must fall within the sectors covered by the event.

By clicking on the submit application button, the exhibitor confirms to IFEMA MADRID that he/she is seriously interested in participating as such and in receiving a proposal.

From the same application form, if the process is not completed, it is possible to request information and quotations, which does not imply a request for quotation and does not require payment of a reservation fee.

In the event that the CONTRACTING COMPANY designates another entity as the BILLING COMPANY, the details of both must be included in the application form. No changes of invoicing company will be authorised after the first invoice has been issued.

Exhibitors who have not paid in full for the space contracted and the costs of the services requested **will not be authorised to occupy the space and, where applicable, will not be handed over the modular stand.**

If the exhibitor renounces his participation, this shall be grounds for forfeiture of the amount paid in advance. If the exhibitor withdraws within 30 days prior to the opening of the Show, full payment for the space may be demanded, even if it is subsequently occupied by another exhibitor.

FIRST ALLOTMENT

Former exhibitors of FIAA 2022 and FIAA 2024 who submit their **Application to Participate before 1 November 2025** will be given priority in the selection of spaces. During the month of November, applications from former exhibitors received in due time and form will be awarded.

NEW REQUESTS FOR PARTICIPATION

Requests for space received after 1 November 2025 will be dealt with on a first-come, first-served basis from 1 December 2025. New exhibitors will choose the location of their stand, once the spaces of former exhibitors have been allocated, in order of receipt of applications and from largest to smallest surface area

1.3 Contracting and allocation of space.

The decision to accept the exhibitor will be at the discretion of IFEMA Madrid, taking into account the purpose of the fair and the availability of space.

IFEMA Madrid will make one or more proposals for space/location depending on the type of participation and/or type and size of stand requested. This proposal constitutes a contracting offer. If the contracting party accepts the offer by email or during the space selection meeting, he/she will be formalising the contract for participation in the fair, which constitutes a binding commitment that cannot be revoked by the applicant.

The space will be allocated after acceptance, in writing, by the exhibitor.

The exhibitor will receive the exhibition contract with the statement of accounts and a plan of the location and dimensions of their stand/s and will then be able to access the Zona Expo customer portal to manage their participation.

It is essential to make the payments indicated in the contract within the established deadlines.

The Show Organisers reserve the right to change stand locations for justified reasons.

1. 1. HOW TO PARTICIPATE. SPECIFIC RULES FOR PARTICIPATION

1.4 Types of participation

- **Exhibitor:** the natural or legal person who has a space at the Show. The exhibiting company is the company in whose name the application to participate as an exhibitor is completed. The exhibitor has the option of contracting a 'basic turnkey' modular stand, a "premium" modular stand or to contract only the space to build his own 'free design stand'.
- **Co-exhibitor:** an individual or legal entity that participates in the stand of an exhibitor, contracting directly with him. The exhibitor must register his co-exhibitors from the Zona Expo customer portal and each co-exhibitor must fill in an application form to participate as a co-exhibitor at the fair.

1.5. Your Exhibitor Plan

Conecta Exhibitor Plan

Participation as a regular exhibitor at the fair requires the contracting of the CONECTA EXHIBITOR PLAN 370€ + VAT (1)

This concept groups together the following services:

- Dissemination of participation in the fair through insertion in the list of exhibitors accessible in open access on the fair's website and shared as a link in sectoral communications.
- Presence as exhibitors in the FIAA LIVE Connect digital event. The digital event extends the duration of the fair beyond its celebration, provides additional contents of the exhibition offer and sectorial news and is accessible to exhibitors and registered visitors.
- Registration of 20 products or services associated with the company file on the LIVE Connect digital platform
- Presence during the trade fair on the hall plans and exhibitor lists.

- Access to IFEMA MADRID's customer portal 'ZONA EXPO' to manage participation.
- Exhibitor passes according to contract (see point 2.3)
- Online invitations according to contract (see point 2.3)
- Discount vouchers for transport.
- Premium wifi connection for 3 users for the duration of the fair (these connections will only work with devices that allow connection in the 5 GHz band). The password will be enabled for the duration of the fair and until the last day of dismantling and will be sent by e-mail to the holder's address at least 48 hours in advance.

- **3-user connection functionalities to generate business opportunities (in LIVE Connect):**

- Search for new contacts among registered visitors and exhibitors
- Communication with contacts (chat and video conferencing)
- Organisation of personal online and face-to-face meetings with contacts
- Preparation of company meetings at the trade fair stand to optimise time
- Scanning of visitor passes at the trade fair
- Downloading of the contact list with your data

UPGRADES

Exhibitors with a stand and their co-exhibitors have the option to purchase the following additional upgrades, which add functionality to the CONECTA plan :

Impacta Exhibitor Plan

UPGRADE RATE IMPACT.....400€ + VAT (1)

- Visibility of the company profile with positioning as a prominent exhibitor.
- Possibility of including unlimited products.
- Possibility of highlighting 2 products.
- Exhibitor team with unlimited users with networking.
- Possibility of offering 2 sessions, seminars or product demonstrations.

1. 1. HOW TO PARTICIPATE. SPECIFIC RULES FOR PARTICIPATION

1.6 Your space at the fair. Types of stands. Regulations and assembly

TYPES OF STAND Types of participation

- **Basic turnkey stand**
- **Premium turnkey stand**
- **Free design stand:** Floor only. Only contracting space to build your own stand, the assembly project of which must be approved by IFEMA MADRID.

Participation with a stand at the fair requires the contracting of the following general services associated with the stand:

- ❖ Civil liability insurance (covers up to €60,000)(*)
- ❖ Multi-fair insurance (covers up to €50,000)(*)
- ❖ Minimum electricity consumption (0.13 kW/m²)(*)
- ❖ Assembly fees (service included in the turnkey stand)(*)
 - **Type A:** spaces without decoration, or occupied by carpeting or dais
 - **Type B:** basic modular stands in aluminium or similar
 - **Type C:** modular design stands in aluminium, carpentry stands and other materials
- ❖ **Conecta Exhibitor Plan (*)**

(*) Services already included in the Basic and Premium turnkey stand.

Special actions for Exhibitors

All FIAA 2026 exhibitors with an allocated stand will have the option of various unique activities, with the aim of boosting their participation.

Test track

There will be a test track for vehicle exhibitors located on the site itself, in which only the same models or finishes that are on display on the stands will be able to participate. Participants will be provided with a map showing the routes indicated for vehicle testing. In order to formalise registration, exhibitors must fill in the 'Test Area Registration Application' form. Registration for the first vehicle is free of charge. From the second vehicle onwards the fee will be €495 + VAT (1).

Press Day

The press day on the first day is a strategic opportunity to present your new products to specialised media and multiply its diffusion from the beginning of the fair. Participating in this day positions you as a protagonist in front of journalists, influencers and sector professionals, generating high-impact media coverage. An outstanding presentation at the press day can translate into interviews, media mentions and reinforced visibility throughout the fair.

Press day slots are limited and will be allocated by the FIAA organisers, who reserve the right to exclude exhibitors who do not meet the established criteria.

For further information, please contact fiaa@ifema.es

1. HOW TO PARTICIPATE. SPECIFIC RULES FOR PARTICIPATION

1.7 Participation Rates

TYPE OF SPACE	RATE
Floor only: from 16,00 to 50,00 sq.m	153,00€/sq.m + VAT (1)
Floor only: from 51,00 to 150,00 sq.m	140,00€/sq.m + VAT (1)
Floor only: from 151,00 to 500,00 sq.m	136,00€/sq.m + VAT (1)
Floor only: from 501,00 to 750,00 sq.m	100,50€/sq.m + VAT (1)
Floor only: from 751,00 to 1.000,00 sq.m	87,50€/sq.m + VAT(1)
Floor only: more than 1.000,00 sq.m	61,50€/sq.m + VAT (1)
Llave en manos Stand BASIC 16,00 sq.m	4.200€ + VAT(1)
Additional sq.m Llave en mano stand BASIC	208,00€/sq.m + VAT (1)
Llave en mano stand PREMIUM 16,00 sq.m	5.392 + VAT (1)
Additional sq.m llave en mano stand PREMIUM	275,00€/sq.m + VAT (1)
Second Floor	42,43€/sq.m + VAT (1)
Outdoor space	43,00 €/sq.m + VAT (1)
Test track	495€ unit + VAT (1)

SERVICES	RATES
Liability insurance (covers up to 60,000€)	72,84€ + VAT (1)
Multi-trade insurance (covers up to 50,000€)	69,15€ + VAT (1)
Minimum electricity consumption (0.13 kW/m ²)	7,65€ + VAT (1)
ASSEMBLY RIGHTS	
Type A: spaces with no decoration, or occupied by carpeting or flooring	2,77€/sq.m + VAT (1)
Type B: basic modular stands in aluminium or similar	5,56€/sq.m + VAT (1)
Type C: modular design stands in aluminium, carpentry stands and other materials.	8,75€/sq.m + VAT (1)

EXHIBITION PLAN CONNECT	370€ + VAT (1)
Coexpositor high rate	370€ + VAT (1)
Upgrade IMPACTA Exhibitor Plan	400€ + VAT (1)

1.8 Terms and methods of payment

DATES FOR PAYMENT

When sending the Participation Application Form, the space reservation fee will be paid, according to the following rates:

- From 16 to 150 sq.m:450€ + VAT (1)
- From 151 to 750 sq.m:..... 750€ + VAT (1)
- From 751 sq.m and over:1.500€ + VAT (1)

➤ **December 1, 2025:** deadline for payment of the first **25% of the contracted space**, discounting the space reservation fee.

➤ **July 31, 2026:** deadline for payment of **75% of the contracted space and services**.

PAYMENT METHODS

You can pay in the following ways:

Transfer to: IFEMA MADRID / FIAA 2026

Santander: IBAN ES64 0049 2222 5115 1000 1900 SWIFT: BSCHESSM

BBVA: IBAN ES89 0182 2370 4000 1429 1351 SWIFT: BBVAESMM

Caixa Bank: IBAN ES93 2100 2220 1102 0020 2452 SWIFT: CAIXESBBXXX

Send a copy of the bank receipt to servifema@ifema.es

- ❖ Certified check made out to IFEMA MADRID/FIAA 2026.
- ❖ Credit card in a secure environment, accessible at the end of the online completion of the participation application form, or later through Zona Expo. In accordance with current regulations, payments in cash or bearer checks are not accepted.

In Zona Expo you will find your statement of accounts of participation in the fair and the invoices, once the payments have been made. If you need an invoice to make a payment, please request it by mail to atencionalcliente@ifema.es.

DISCOUNTS:

5% DISCOUNT ON SERVICES CONTRACTED THROUGH THE EXPO ZONE, UP TO 30 DAYS BEFORE THE START OF THE ASSEMBLY.

This discount will also be applicable to services contracted by sending the plan of your stand to the technical secretariat. Mandatory minimum services are not included: outdoor advertising, meeting rooms, graphic decoration of stands or specific services of the fair such as exhibitor passes, invitations...

SURCHARGES:

25% increase for contracting services, including assembly fees, requested 7 days prior to the start of assembly (September 9, 2026).

(1) Companies established in Spanish territory (excluding the Canary Islands, Ceuta and Melilla): 10% VAT not included. For all other companies this operation is not subject to Spanish VAT. In the case of companies from the European Union, the exhibitor will be responsible for the VAT which, if applicable, is due in their country of establishment.

1. HOW TO PARTICIPATE. SPECIFIC RULES FOR PARTICIPATION

FIAA

STAND TYPES

BASIC TURNKEY BOOTH

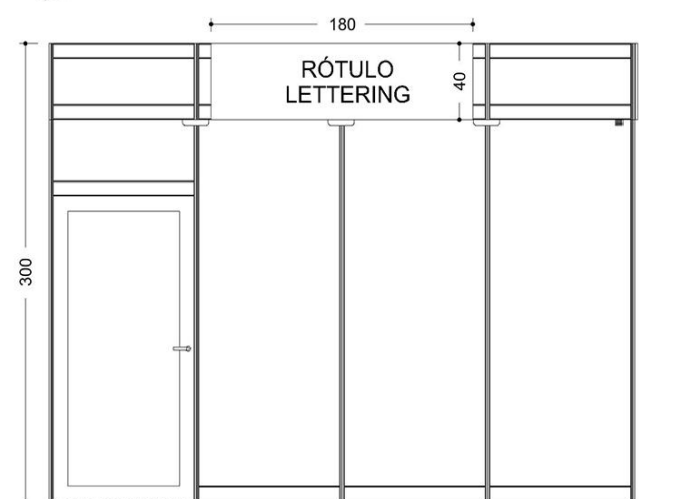

STAND

Stand open to one or several aisles depending on location.
Aluminum structure in gray color and melamine walls.

WAREHOUSE with lockable door in the following proportion:

Up to 16 sq.m1x1 m
From 16,5 to 32 sq.m2x1 m
Over 32,5 sq.m.....3x1 m

FAIR TYPE MOQUETA

5 colors to choose in Zona Expo. Jasper gray by default. The exhibitor must indicate the chosen carpet color by **August 28, 2026**.
If no color is indicated, the default color will be jasper gray.



ELECTRICAL ENERGY AND LIGHTING

- Lighting by means of LED spotlights on rails at a rate of 1 spotlight every 3sq.m of stand.
- Electrical panel with magneto-thermal differential with a 500W socket base incorporated, prepared for a power of 130W/sq.m.

SIGNAGE

Standardized lettering with name of exhibitor editable in EXPO ZONE and booth number. **Maximum 20 characters**.
If the exhibitor's name field in the EXPO ZONE is not filled in, it will be labeled with the Fair Name of the Participation Application. The exhibitor must indicate the company name chosen for the sign before **September 4, 2026**.

FURNITURE INCLUDED (regardless of the sq.m built):

- 1 White Katyn round table (6RL02002)
- 4 Madrid white chairs (6RL01001)
- 1 Coat rack Indo white (6RL06001)
- 1 Torne white counters (6RL08002)
- 1 Shelf Niagara white (6RL07001)
- 1 Stool Pisa white (6RL01063)
- 1 Wastebasket Duero white (6RL04003)



OBLIGATORY CONTRACTING

In addition, participation as an exhibitor implies the obligatory contracting of the PLAN CONECTA (former Marketing and Communication pack): 370€ + VAT (1)

SERVICES INCLUDED

- Daily cleaning of the stand (Type A, once a day).
- Set-up fees included in the price.
- Multi-fair and civil liability insurance included in the price.
- Minimum electricity consumption (0.13 Kw /sq.m).
- CONECTA exhibitor plan.

TYPE A CLEANING

First cleaning with removal of the plastic covering the carpet and daily cleaning of the floor and collection of the contents of the garbage cans. It does not include the cleaning of the exhibits.

ASSEMBLY PLAN

Your assembly plan can be viewed in the EXPO ZONE with the location of the warehouse and other services included. In addition, you can monitor the status of the plan and make comments on it, in case you need to make any changes.

ADDITIONAL SERVICES

Customize your modular stand with our Stand Graphic Decoration service decoraciongrafica@ifema

DRAWING AS A GUIDE. No drilling or nailing is allowed. Adhesive tape may be used, provided that its removal does not damage the panels. It must be adapted to the dimensions of the space allotted.

REMARKS: - Any services or modifications that may be required based on these characteristics shall be at the exhibitor's expense. - The elimination or substitution, by the exhibitor, of any formative element of the modular stand does not imply a reduction in the cost. - The distribution of all the elements that make up the stand, the extras requested, as well as the structural elements necessary for the support of the stand, will be adapted to the needs of the exhibitor, as long as it is technically feasible and the plan with the pertinent indications is received fifteen days before the first day of the beginning of the assembly. Once the stand has been assembled, any changes in the location of all the elements that have not been communicated on the established date will be invoiced. - All the material used, both structural and electrical, is rented and any deterioration will be invoiced according to current rates. - In addition, any exhibitor may hire elements listed in the IFEMA Services Catalogue.

1. HOW TO PARTICIPATE. SPECIFIC RULES FOR PARTICIPATION

STAND TYPES

STAND MODULAR PREMIUM

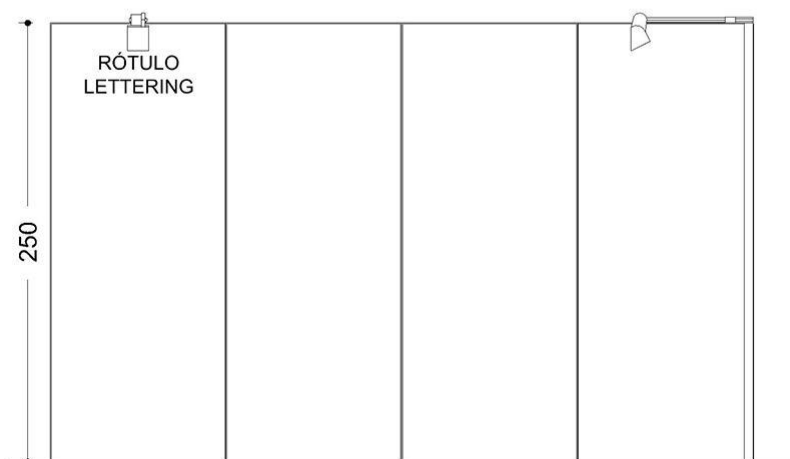

STAND

Stand open to one or more aisles according to the allocation plan.

Structure: aluminum frames 2.5 m high with white PVC walls. Any change of color will be billed as an extra, subject to a prior quote request.

WAREHOUSE with lockable door in the following proportion:

Up to 16 sq.m.....1x1 m
 From 16 to 32 sq.m2x1 m
 Over 32 sq.m.....3x1 m

FAIR-TYPE CARPET

5 colors to choose from in the EXPO ZONE. The exhibitor must indicate the chosen carpet color before August 28, 2026..In case of not indicating the color, the default color will be Leaf Green.

Any exhibitor who wishes to do so may install perimeter carpeting in his stand.



ELECTRICAL ENERGY AND LIGHTING

- Lighting by means of 25w led arm spotlights per 4 sq.m
- Electrical panel with magneto-thermal differential with a built-in socket base, prepared for a power of 130W/ sq.m.
- A double socket base

SIGNAGE

Signage in standardized lettering with name of exhibitor editable in EXPO ZONE and booth number. **Maximum 20 characters.**

If the exhibitor's name field in the EXPO ZONE is not filled in, it will be labeled with the Fair Name of the Participation Application. The exhibitor must indicate the company name chosen for the sign before **September 4, 2026.**

FURNITURE INCLUDED (regardless of the sq.m built):

- 1 Everest table (6RL02026)
- 4 New York Chairs black (6RL01045)
- 1 Black Indo coat rack (6RL06002)
- 1 Counter Torne White (6RL08002)
- 1 Shelf Niagara white (6RL07001)
- 1 Stool Lima (6RL01009)
- 1 Wastebasket Duero black (6RL04004)



FIAA

OBLIGATORY CONTRACTING

In addition, participation as an exhibitor implies the obligatory contracting of the **CONECTA PLAN** (former Marketing and Communication pack): 370€ + VAT.

SERVICES INCLUDED

- Daily cleaning of the stand (Type A).
- Assembly fees.
- Multi-fair and civil liability insurance included in the price.
- Minimum electricity consumption (0,13 Kw /sq.m).
- Parking
- CONECTA exhibitor plan.

TYPE A CLEANING

First cleaning with removal of the plastic covering the carpet and daily cleaning of the floor and collection of the contents of the garbage cans. Does not include cleaning of exhibits.

INSTALLATION DRAWING

Your assembly plan can be viewed in the EXPO ZONE with the location of the warehouse and other services included. In addition, you can track the status of the plan and comment on it, in case you need to make any changes.

ADDITIONAL SERVICES

Customize your modular booth contacting standspremium@ifema.es

DRAWING AS A GUIDE. It is not allowed to drill holes, nail or glue.

REMARKS: - All services or modifications to be introduced from these characteristics shall be at the exhibitor's expense. - The elimination or substitution, by the exhibitor, of any formative element of the modular stand does not imply a reduction of the cost. - The distribution of all the elements that make up the stand, the extras requested, as well as the structural elements necessary for the support of the stand, will be adapted to the needs of the exhibitor, as long as it is technically feasible and the plan with the pertinent indications is received fifteen days before the first day of the beginning of the assembly. Once the stand has been assembled, any changes in the location of all the elements that have not been communicated on the established date will be invoiced. - All the material used, both structural and electrical, is rented and any deterioration will be invoiced according to the current rates. - In addition, any exhibitor may hire elements listed in the IFEMA Services Catalogue.

1. HOW TO PARTICIPATE. SPECIFIC RULES FOR PARTICIPATION

FIAA

REGULATIONS AND ASSEMBLY OF YOUR SPACE

ASSEMBLY AND DISASSEMBLY

All companies will be obliged to set up their booth, including at least the dividing walls with the pavilion wall and with the adjoining booths, depending on their location.

The assembly of free-design stands may be carried out from **18 to 21 September 2026** during the following hours:

✓ from 6:30 am to 9:30 pm.

The delivery of modular stands contracted with IFEMA MADRID will be made on **September 21, 2026** from 8:30 a.m.

Exhibitors who have not paid in full for the space contracted and the costs of the services requested will not be authorized to occupy the space and will not be given the modular stand.

The entry of merchandise and decoration material may take place from **September 20th from 8:30 a.m. to 9:30 p.m. On September 21, from 7:00 p.m.** onwards, entry will only be possible through the pedestrian gates, closing the goods gates to proceed with the installation of recyclable carpeting..

Goods and decoration material may be removed on **September 24 from 7:30 p.m. to 00:00 p.m. From 7:30 p.m. to 8:30 p.m.** the exit can only be made through the pedestrian gates to proceed with the removal of recyclable carpeting. After this time, the merchandise gates will be open until 00:00 p.m. **On September 25th from 8:30 a.m to 3:00 p.m.**

Stands may be **dismantled** on **September 25 from 3:00 p.m. to 9:30 p.m. and on September 26 from 8:30 a.m. to 07:30 p.m.**

General assembly regulations

For **safety** reasons, and as a general and permanent preventive measure due to the concurrence of activities, it is mandatory to wear a protective helmet, **high visibility vest and safety shoes during the assembly and disassembly phases of fairs and events in all exhibition areas.**

During assembly it is not necessary to carry passes, so there are no assembly passes.

No assembly work may begin without the prior completion and submission to IFEMA of the Protocol "[Prevention of Occupational Risks and Coordination of Business Activities](#)" available on the IFEMA MADRID ifema.es website. es -Exhibitors -Participation Rules -Forms (Article 15 of the general rules for participation in fairs organized by IFEMA MADRID. available on the IFEMA MADRID website ifema.es -Exhibitors - Participation Rules -Forms (Article 15 of the general rules for participation in fairs organized by IFEMA MADRID. available on the IFEMA MADRID website ifema.es -Exhibitors -Participation Rules -Forms (Article 15 of the general rules for participation in fairs organized by IFEMA MADRID. available on the IFEMA MADRID website. available on the IFEMA MADRID website.

Regulations for the circulation and parking of vehicles during the event: inside the fairgrounds it is expressly forbidden to keep vehicles parked in the loading and unloading areas, so that they may only be parked in the areas designated for this purpose, paying the corresponding fee, if applicable. Once the event has opened, it is not allowed to circulate with any vehicle inside the halls and the avenue, unless expressly authorized by IFEMA MADRID (article 14 of the general provisions of the General Rules of Participation of IFEMA MADRID).

Management of waste and assembly and exhibition materials: all companies participating in the assembly and dismantling of stands at the fair/event must manage, as directly responsible, the waste they generate for its removal within the deadlines set. IFEMA MADRID will make available the possibility of hiring containers to facilitate the selection and removal of waste and will supervise the same (see rates in the Expo Zone Customer Portal, in Contracting Services, section on cleaning and waste containers.

The exhibitor shall lose any right to claim for loss or damage to materials still remaining in the exhibition areas of the pavilion at the end of the period and shall bear the costs related to their removal, which will be invoiced by IFEMA MADRID in accordance with the established rates (see art. 35 of the general regulations for exhibitors' participation in events organized by IFEMA MADRID).

SPECIAL AUTHORIZATIONS

On the ifema.es website, you will find a list of other services, regulations and forms that may be of interest to you:

[Communication for the realization of catering in stands.](#)

- ◆ Occupational risk prevention and coordination of business activities.
- ◆ Request for authorization of private security guards at stands.
- ◆ Authorization request for wifi installation.
- ◆ Authorization request for antenna cabling.
- ◆ Request for authorization to hang structures/rigging.

Exhibitor regulations

1. HOW TO PARTICIPATE. SPECIFIC RULES FOR PARTICIPATION

REGULATIONS AND ASSEMBLY OF YOUR SPACE

Installation of recyclable carpeting in common areas: in line with IFEMA MADRID's commitment to the 2030 SDGs (United Nations Sustainable Development Goals), as indicated in the [Guide for Sustainable Participation in Fairs and Events](#), and with the aim of optimizing the process of installation and removal of recyclable fair carpeting for subsequent reuse and consequent elimination of the protective plastic at source, the schedules of entry and exit of goods must be adapted to these processes and will be reflected in the corresponding point. Thank you for your collaboration with our environmental commitment.

IFEMA MADRID carpets the aisles throughout the fair and, for reasons of sustainability, does so with reusable strips of standard sizes and, as a result, leaving a small strip of carpet free on the edges of the aisle/s that border the stands. **These non-carpeted strips are part of the aisle and not of the stands and therefore the exhibitor is not authorized to cover or decorate them.** We request the exhibitor's cooperation in respecting this decision; IFEMA MADRID staff will monitor compliance as far as possible, and will demand the removal of any carpeting that invades these strips and, if, **despite the controls, the strip is invaded, the invaded aisle space will be invoiced to the exhibitor as space.**

Once the stand has been set up, any changes in the location of all the elements that have not been communicated on the established date will be invoiced.

To contract services, you must do so through our online channel, which you can access from the following link: [Commerce](#).

Turnkey stands. Regulations and customization.

All modular booths involving interior decoration with panels, profiles, totems, platforms, trusses, etc., are **REQUIRED to UPDATE their project in THEIR EXPO ZONE by August 28, 2026.**

The elimination or substitution, by the exhibitor, of any element of the modular stand does not imply a reduction in cost. All the material used, both structural and electrical, is rented and any deterioration will be invoiced according to the current rates.

The distribution of all the elements that make up the stand, the requested extras, as well as the structural elements necessary for the support of the stand, will be adapted to the needs of the exhibitor, as long as it is technically feasible and the plan with the pertinent indications IS UPLOADED IN THE EXPO ZONE 15 days before the beginning of the assembly: September 1, 2026.

CUSTOMIZE YOUR BOOTH WITH US: GRAPHIC DECORATION FOR BOOTHS

Customize your modular stand with the image of your brand, to generate maximum impact on visitors. We offer you a wide range of graphic materials (vinyl, foam, Forex, canvas...) versatile and adaptable to all the elements of your stand (walls, furniture, fronts, banners, displays...). Ask for more information and quotation. Our specialized team will follow up the production and installation. decoraciongrafica@ifema.es

Once the stand has been set up, any changes in the location of all the elements that have not been communicated on the established date will be invoiced.

1. HOW TO PARTICIPATE. SPECIFIC RULES FOR PARTICIPATION

Free design stands. Regulations and assembly

Companies opting for free construction of their **booths** must **SUBMIT THEIR EXPO ZONE the project for approval, before August 14, 2026.**

If your project involves rigging, you must complete the Application to hang structures/rigging | IFEMA MADRID before August 14, 2026.

Assembly rights

The company in charge of the assembly work of a stand must pay IFEMA MADRID, before starting such work, the assembly fees corresponding to the services rendered during the period of assembly and dismantling of the Fair. In the event that, as the exhibitor, you wish to assume the payment of these assembly fees and have them included in your invoice, you must contract them at the Expo Zone.

In order to be more efficient and provide a better service, avoiding incidents in the assemblies, IFEMA MADRID has begun to apply a last minute **surcharge to the contracting of assembly rights, as happens with the rest of our services.**

Este recargo incrementa el precio en un 25% cuando la contratación se realice durante la semana previa (7 días anteriores) al inicio del montaje, durante el montaje, celebración y desmontaje.

Le recordamos que los derechos de montaje se aplican a los montajes de diseño libre y que pueden ser contratados con un 5% de descuento si la contratación se realiza hasta 30 días antes del comienzo del montaje de la feria.

First floor.
Maximum occupancy first floor.

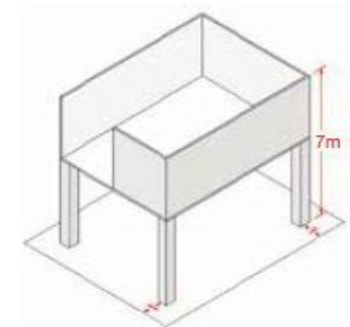

Height regulations.
Maximum spatial occupation to be occupied by any element.

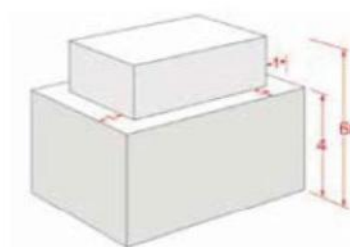

Enclosures

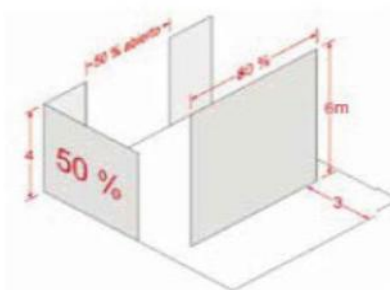
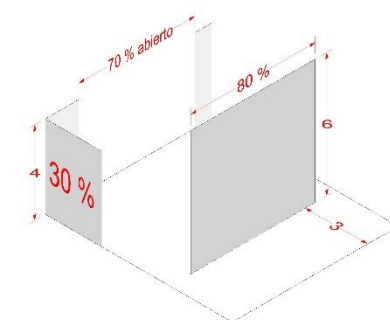

SPECIFIC ASSEMBLY RULES FOR FREE-DESIGN STANDS

Height

- Maximum authorized height in perimeter line: 4 m.
- In order to raise or hang any decorative element to a maximum height of 6 m, it is necessary to set back 1 m inward along the entire perimeter.
- This possibility does not exist in the connecting cores between pavilions, nor on the entrance sides of pavilions 9 and 10.
- Construction elements, decoration and spotlights may not protrude more than 50 cm from the allotted space and from a minimum height of 2.5 m.

Blind enclosures in the perimeter environment

- Blind perimeter enclosures for vehicle stands may not exceed 30% of the façade of each aisle. Even if it is less than 30%, it is not permitted to enclose the entire width of one side of the stand. Other types of exhibitor that do not display vehicles may enclose up to 50% of each aisle façade.
- For longer enclosures, these must be set back a minimum of 3 m inward and may not exceed 50% of the length of the facade.

Second floor

- The permitted height for two-story stands in pavilions is 7m.
- The second floor must be set back 1 m around the perimeter of the stand.
- In the connecting cores between halls and in the side entrance areas to Halls 9 and 10, the construction of a second floor is not permitted.
- Exhibitors must present a certificate specifying the dimensions, the load of use and the capacity, being the sole responsibility of the exhibitor to comply with the limits established therein.

The interpretation and application of the regulations for each particular case is the responsibility of IFEMA MADRID, which reserves the right to make exceptions if deemed necessary, based on respect for the general perspective of the event and the visibility of neighboring stands.

DESIGN YOUR BOOTH WITH US

In addition to turnkey stands, we offer you a complete stand design service, with our guarantee and totally adapted to your needs. We take care of the planning of your space, design, assembly and disassembly. Request, free of charge and without obligation, a project tailored to your needs by sending an email to infodesign@ifema.es.

[I want to know more](#)

To contract services, you must go through our online channel, which you can access from the following link: [Commerce](#).

1. HOW TO PARTICIPATE. SPECIFIC RULES FOR PARTICIPATION

FIAA

1.9 Specific rules of participation

The decision to accept the exhibitor will be at the discretion of IFEMA Madrid taking into account the purpose of the fair and the availability of space. The minimum surface area for contracting is 16 sq.m.

The management of the fair may alter the assigned spaces or make changes in the distribution of the pavilions for organizational reasons. Without prejudice to the Management of the fair informing exhibitors in case of relocation or significant alteration of the reserved location, each exhibitor is obliged to inform himself of the location of his stand, its exact dimensions, etc.

No exhibitor or visitor who cannot be accredited as belonging to the participating professional groups is allowed access, even if they have the corresponding pass or invitation. The exhibitor is obliged to attend his stand and remain with the products exhibited during the entire period and opening hours of the event. Failure to comply with these regulations could mean the loss of the right to preferential renewal of the space allocated.

The direct sale of any type of articles exhibited at the fair is strictly forbidden. The exhibitor authorizes IFEMA MADRID the possible total or partial reproduction of the products exhibited in its promotional material.

The exhibitor agrees to respect the rules and guidelines for the protection of the environment.

Activities that may disturb other exhibitors are prohibited and may not exceed 60 decibels.

Promotional activities, distribution and exhibition of samples, brochures, leaflets, flyers and all kinds of promotional material shall be carried out only within the space of each exhibitor. Activities requiring the contracting of a catering service during the fair will require the completion of the "Communication form for catering at stands" available at ifema.es and which should be sent to: catering@ifema.es The installation by exhibitors of WIFI access points, either for INTERNET connection or for the presentation of other functionalities, is expressly forbidden.

The purpose of this measure is to avoid interference problems, both with the points that may be installed independently by each Exhibitor, as well as the access points of IFEMA MADRID. Such interference could cause the WIFI networks present not to work. For further information, please refer to Article 33 of the General Regulations for Exhibitor Participation in Exhibitions Organized by IFEMA MADRID.

CHANGES IN PARTICIPATION

Once space has been awarded to a company, requests to change the dimensions of the space may involve changes in location.

CANCELATION

The Exhibitor's withdrawal from participation in the Show shall be grounds for termination of the contractual relationship between IFEMA MADRID and the Exhibitor for all purposes. The resignation must be communicated to the Show Management in writing addressed to the same and will entail the loss of the amounts that the exhibitor should have paid at the date of communication, according to the schedule of payment deadlines reflected in the Application for Participation. If the cancellation has been communicated to the Show Management within thirty days prior to the opening of the event, IFEMA MADRID may require the exhibitor to pay the full amount of the contracted space.

In relation to the additional services offered by IFEMA MADRID that the exhibitor had contracted prior to the communication of the cancellation, the cancellation charges established in article 7 of the general conditions of admission and contracting in events organized by IFEMA MADRID will be applicable.

In the **event of cancellation** of the fair due to force majeure, the amounts paid for concepts related to on-site participation will be refunded, according to Article 15 of the **General Rules of Participation in events organized by IFEMA MADRID**.

These Specific Rules, including the participation and set-up regulations of this chapter, are complemented by the **General Regulations for Exhibitors' Participation in Exhibitions Organized by IFEMA MADRID**, which all exhibitors, by virtue of being exhibitors, accept.

1. HOW TO PARTICIPATE. SPECIFIC RULES FOR PARTICIPATION

1.10. Calendar

When	What	How	Who's attends you
From September 1, 2025	Application for participation	- Send the Online Participation Application Form available on the FIAA website along with proof of payment of the space contracting fee to exercise your preferential right in the choice of space.	Address of the contest: fiaa@ifema.es Customer service: (+34)91 722 30 00 atencionalcliente@ifema.es
Until December 1, 2025 Until July 31, 2026	Payments	- Until December 1, 2025: 25% of the amount of the space discounting the reservation fee paid. - Until July 31, 2026: 100% of the amount of the space and services contracted.	Servifema Customer service: (+34)91 722 30 00 atencionalcliente@ifema.es
Until August 14, 2026	Free design projects	Deadline for uploading free design projects to the EXPO ZONE. If the project includes hanging elements, you must submit a separate project and send it to rigging@ifema.es.	Technical Secretariat Customer service: (+34)91 722 30 00 atencionalcliente@ifema.es
Until August 16, 2026	Contracting of services	Services contracted with a 5% discount.	Customer service: (+34)91 722 30 00 atencionalcliente@ifema.es
June 1 to November 30, 2026	Access to the digital event	Access to the digital platform for exhibitors and visitors. Networking, preparation, participation and follow-up of the fair.	Customer service: (+34)91 722 30 00 atencionalcliente@ifema.es
Before September 1, 2026	Customization of modular stands	- Submit projects for interior decoration of modular stands. - Choose carpet color at ZONA EXPO before August 28, 2026. - Communicate the signage in ZONA EXPO before September 4, 2026. - The modular booth project must be consulted at ZONA EXPO, or upload the same with the stipulated modifications.	Technical Secretariat Customer service: (+34)91 722 30 00 atencionalcliente@ifema.es

1. HOW TO PARTICIPATE. SPECIFIC RULES FOR PARTICIPATION

1.10. Calendar

When	What	How	Who's attends you
As of September 9, 2026	Contracting of services	25% increase on prices for last minute contracting of assembly rights and other services.	Customer service: (+34) 91 722 30 00 atencionalcliente@ifema.es
September 18 to 21, 2026	Stand assembly	- From September 18 to 21 from 6:30 a.m. to 9:30 p.m.	-
September 20 and 21, 2026	Delivery of modular stands	September 21, starting at 8:30 a.m.	Hall manager
	Goods receipt	- From 8:30 a.m to 9:30 p.m. - From 7:00 p.m. onwards, entry will only be possible through the pedestrian doors, closing the goods gates to proceed with the installation of recyclable carpeting in aisles.	Hall manager
September 22 to 24, 2026	Celebration of the fair	Hours from 10:00 a.m. to 7:00 p.m.	-
September 24 and 25, 2026	Goods issue	September 24th from 7:30 p.m. to 00:00p.m. From 7:30 p.m. to 8:30 p.m., exit will only be possible through the pedestrian gates to proceed with the removal of recyclable carpet. After this time, the merchandise gates will be opened until 00:00 p.m. On September 25th from 8:30 a.m. to 3:00 p.m.	Hall manager
September 26 and 27, 2026	Dismantling of stands	On September 25 from 3:00 p.m. to 9:30 p.m. September 26th from 8:30 a.m. to 7:30 p.m.	Hall manager

2.1. Expo Zone. Manage your participation and your space. Contracting additional services. E-commerce

Access our customer area Zona Expo from the web: www.ifema.es/en/fiaa to manage your company data, your contacts and everything related to your participation. You will be able to access your participation once you have confirmed your participation with your user name (the e-mail address you used to fill in the application form).

What can I do from Zona Expo?

- Access the details of each participation, plans and projects.
- Access the exhibitor's calendar.- View documents of interest.
- Manage exhibitor passes and request visa support letters.
- Download discount vouchers: Renfe, Iberia.
- Send invitations.- Register co-exhibitors.
- Access orders, payments, account status and invoices issued.
- Upload free design stand projects.- Request the distribution of elements of modular stands, coat racks or shelves, add the sign and choose the color of the carpet.
- Access the e-commerce to contract services.
- Access the digital platform to manage catalog and networking.

The [following video](#) shows a tutorial on the use of the EXPO ZONE

2.2. LIVE Connect: the digital platform to which you have access with your Plan

LIVE CONNECT is the digital ecosystem that **fosters connections with other professionals**, facilitates meeting preparation, offers exclusive content and activities, and generates business opportunities.

Business and networking

Identify leads to generate business and schedule high-value meetings.

Post-show ecosystem

Activity and visibility after the show: access and share content, follow up your contacts and much more.

Positioning

Highlight your company and increase the visibility of your offer.

What can I do from the MY COMPANY area in LIVE Connect?

- Update my company's data visible in the web catalog and on the platform.
- Add my products and services, which will be visible on the FIAA LIVE Connect digital platform.
- Register users from my team to access the digital event.
- Manage the exhibiting company's agenda and company meetings at my booth at the fair.

What can I do at the digital event?

- Search for contacts of interest in the professional network
- Request and accept to be a contact to chat and hold videoconferences
- Request and/or accept appointments for professional meetings at my stand at the fair or by videoconference.
- Complete my professional profile as a user of the platform and my personal availability agenda for meetings.
- View information about the offer of other exhibitors.
- Consult the activities and conferences both on-site and online and enter them in the agenda
- Scan visitor badges at the fair Download my contact list.

2.3. Registration of COEXPOSITORS

The registration of co-exhibitors must be done by the exhibitor from the EXPO ZONE, section "Manage your participation/Attach co-exhibitors".

To register, it is essential to enter a correct and unique e-mail address for each co-exhibitor and indicate whether the participation fee (PLAN CONECTA) will be paid by the exhibitor or by the co-exhibitor.

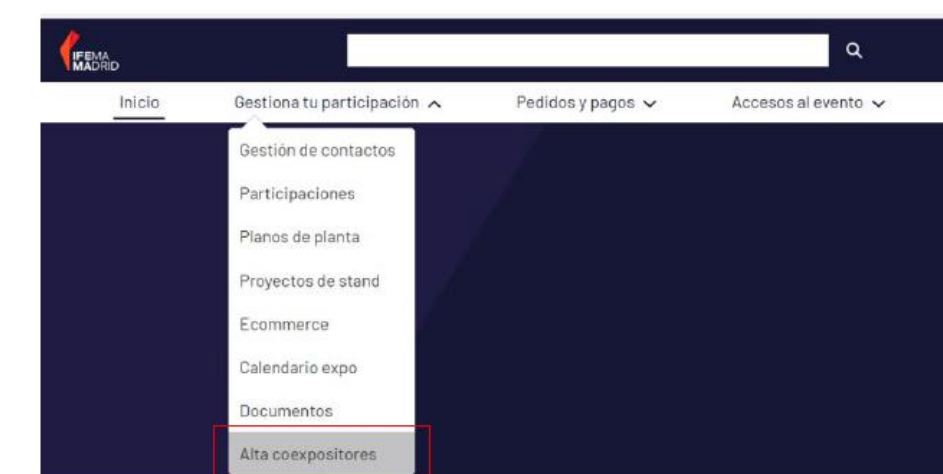

The condition of co-exhibitor implies the mandatory contracting of the elements included in the CONECTA PLAN (*Marketing and Communication Pack + LIVE Connect*):

High rate per co-exhibitor 370,00 + VAT (1)

(1) Companies established in Spanish territory (excluding the Canary Islands, Ceuta and Melilla): 10% VAT not included. For all other companies this operation is not subject to Spanish VAT. In the case of companies from the European Union, the exhibitor will be responsible for the VAT which, if applicable, is due in their country of establishment.

2. MANAGE YOUR PARTICIPATION

Once this process has been completed, the co-exhibitor will receive a unique code to be included in his participation application*.

***If the exhibitor assumes the cost of participation of the co-exhibitor, its registration will be confirmed with the sending of the participation application (essential requirement).**

***If the co-exhibiting company assumes the cost of its participation, its registration will be confirmed with the sending of the participation application and the payment of the corresponding amount.**

Each registered co-exhibitor will have at its disposal the elements included in the CONECTA COEXHIBITOR PLAN:

- Access to the digital platform of the event.
- Presence in the online exhibitors' catalog.
- Visibility in the official exhibitors list accessible at ifema.es/cr
- Access to your own EXPO ZONE.6 Exhibitor Passes.3,000 online invitations.

2.4. Exhibitor/co-exhibitor passes, transportation discount vouchers, visas and invitations

EXHIBITOR BADGES

Exhibitor passes will be managed from ZONA EXPO, in the section "Access to the event/Exhibitor passes".



Each exhibitor will be assigned the passes corresponding to the contracted surface area (6 free EXHIBITOR passes for stands up to 50 sq.m and 1 pass for each additional 10 sq.m up to a maximum of 30 sq.m. 6 free CO-EXHIBITOR passes for stands up to 50 sq.m and 1 pass for each additional 10 sq.m up to a maximum of 30 sq.m). In order to ensure professionalism at the fair, all exhibitor passes will be personalized: they will include the name of the pass holder, company and country. In order to avoid misuse, identity checks may be carried out at the fair entrances.

The [following video](#) shows a tutorial on the use of the EXPO ZONE

Exhibitors may purchase additional exhibitor passes (3.50€/each +VAT) through ZONA EXPO.



COEXHIBITOR PASSES

The co-exhibitor must manage **their 6 exhibitor** passes and online invitations from the **EXPO ZONE**.



2. MANAGE YOUR PARTICIPATION

ONLINE INVITATIONS

Each exhibitor will have professional invitations online to send to their contacts. If additional invitations are required, please send an email to: fiaa@ifema.es, indicating the exact number of invitations.

Online registration will be open until September 24, 2026. Exhibitors will have 3,000 electronic invitations.

Co-exhibitors will have the same number of invitations. Invitations will be sent through "EXPO ZONE/Access to the event/Invitations/Manage invitations".



The [following video](#) shows a tutorial on the use of the EXPO ZONE

We appeal to exhibitors to make good use of the invitations, sending them exclusively to professionals of the sector in order to guarantee the professionalism of the fair. Access controls may be carried out for this purpose.

Professionals who receive the invitation code must register ONLINE through the FIAA website, in the "Purchase your pass" section and enter the invitation code received to obtain their free pass to access the fair. (Invitation codes cannot be redeemed over the counter). It will be absolutely necessary for all Professional Visitors who are going to access the fairgrounds with a Professional Invitation, to be accredited as Professionals, through ifema.es/fiaa.

VISA MANAGEMENT

If you require a visa to travel, you can request from **ZONA EXPO**, the letters of **support to manage** it. To do so, you must first **customize the exhibitor** pass and have **formalized the payment** of your participation following the payment schedule (see point 1.8).

Once these two requirements are fulfilled, from "EXPO ZONE/Event Access/Exhibitor Passes" you will have access to the "Request visa support letter" button. We advise you to start the formalities as soon as possible, since the deadline for visa applications is usually at least 30 days before traveling.

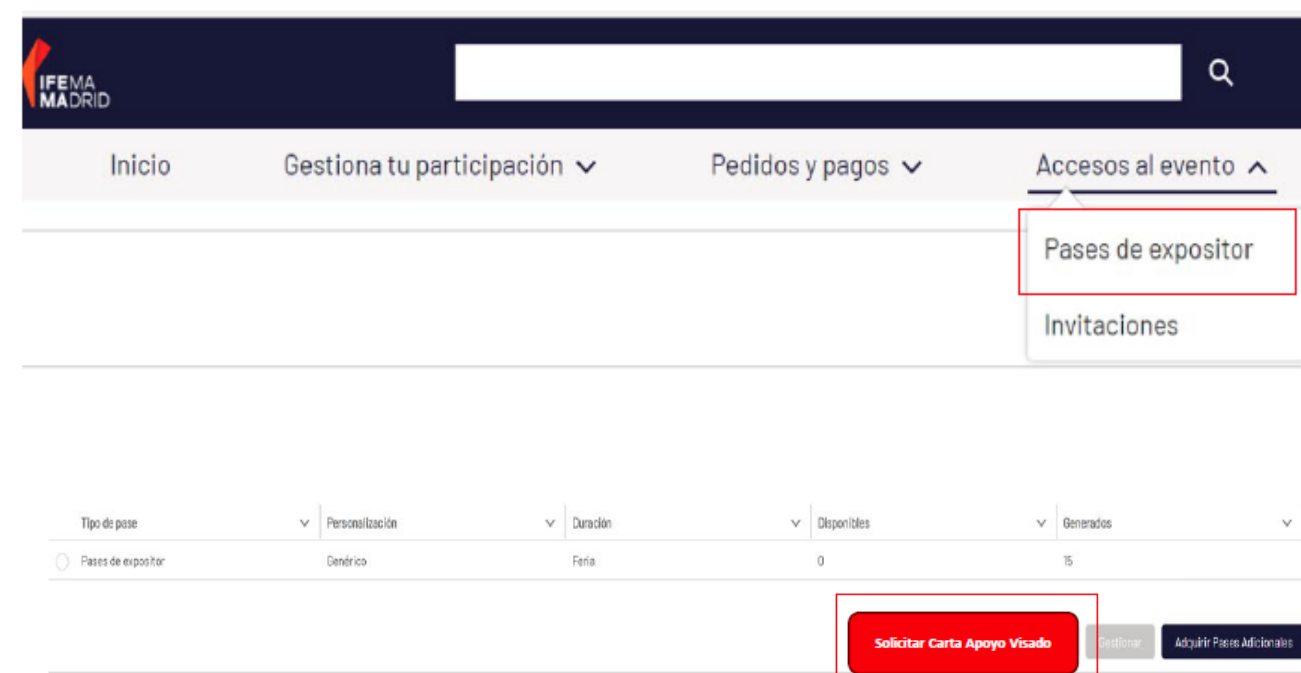

DISCOUNT VOUCHERS FOR TRANSPORTATION

Once the exhibitor passes have been requested, **the corresponding discount vouchers for transportation can be downloaded from ZONA EXPO**, in the section "Manage your participation/Documents".

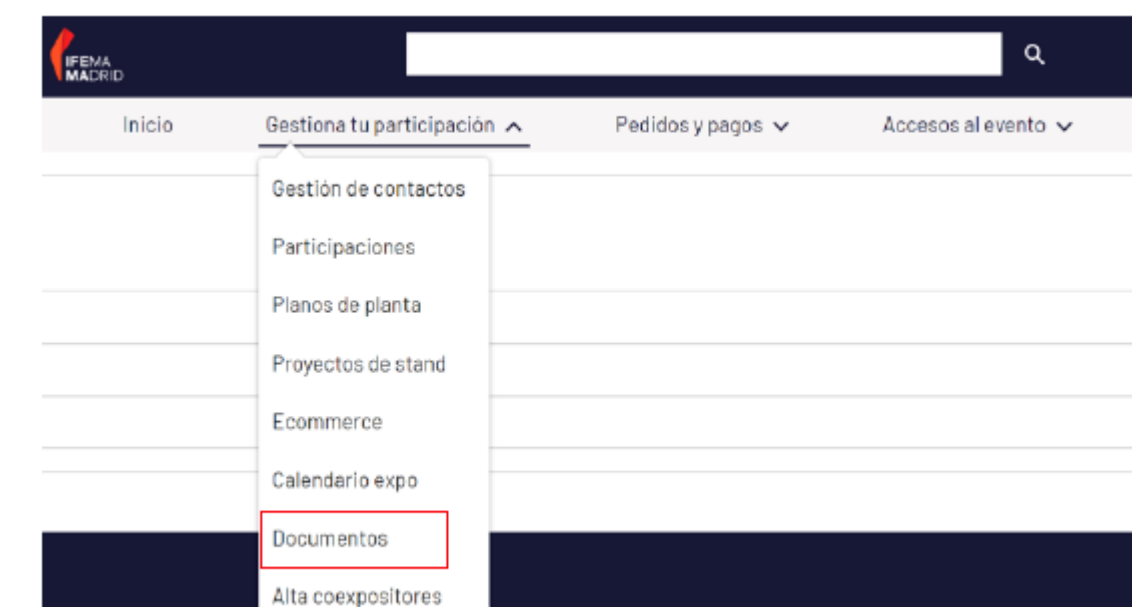

2.6 Other relevant information

SHIPMENT OF GOODS TO THE SITE

IFEMA MADRID staff is not authorized to receive any goods destined for your stand. To send goods to the venue the exhibitor must indicate in the delivery address:

- ♦ IFEMA MADRID (Avda. del Partenón, 5. 28042 Madrid.Spain)
- ♦ FIAA Fair
- ♦ Name of your company.
- ♦ Pavilion and stand number.

The goods must be received by your company's personnel at your stand and arrive during the days set aside for the entry of goods and decoration.

In case it is not possible to comply with the above, we recommend you to contact our partner company for goods management (handling and warehousing):

DB Schenker office at IFEMA MADRID: Pavilion 7

Telephone: +34 91 330 51 77

ifema.madrid@dbschenker.com

CUSTOMS REGULATIONS

1. All products coming from non-EU countries must go through customs procedures, with special mention to the fact that since January 1, 2020, the United Kingdom has been treated as a third country, so all shipments originating in the United Kingdom must regularize their merchandise through the corresponding customs procedure.

2. Exhibiting companies must have the details of the customs agent who carries out the clearance of their goods or, failing that, a copy of the customs documentation of entry into the European Union.

3. The material or merchandise for distribution or consumption must pay Spanish taxes, even if they are products with no commercial value (depending on the country, the amount of taxes may vary).

4. All goods subject to a temporary regime must not be moved from the stand or leave the IFEMA MADRID Exhibition Center until their situation has changed and customs formalities have been completed. It may only be deposited during these procedures in the warehouse of the official logistics agent within the Fairgrounds.

5. It is strictly forbidden to exhibit, sell, consume or distribute non-Community goods at a trade fair before the goods have been cleared through customs. This includes promotional material.

6. Products that are transported as hand luggage must be declared at Barajas Airport in the RED CHANNEL ("Something to declare") and must regularize the merchandise with the corresponding authority at the airport.

7. Goods that have not passed customs control and are on display will be confiscated by the customs authorities operating at the Fairgrounds until the appropriate documents are presented.

8. All trucks arriving at IFEMA MADRID under a transit consigned to IFEMA MADRID, must go to the warehouse of the official Logistics Operator, for the regularization of the goods transported, located at:

Avenida Partenón s/n

West Entrance - Access to calle Rivera del Sena

Service Pavilion Hall 2

28042 Madrid

In order to avoid unwanted situations, and for any questions that may arise, you can contact our Customs Logistics Operator, DB SCHENKER: (+34) 91 330 51 77; email: ifema.madrid@dbschenker.com

CATERING AT THE STAND

Exhibitors who are going to offer, free of charge, [catering/catering at their stand](#), must fill in the form. "Available on the IFEMA MADRID website and send it with all the requested data to catering@ifema.es.

There is a parking area for catering vehicles and refrigerated trucks, with the possibility of electrical connection. You can hire it through the eCommerce.

PARKING CATERING / REFRIGERATED TRUCKS

It is possible to bring in goods uninterruptedly through the service doors, located at the back of the pavilions. We will inform you later on about the gates set up for this purpose and the timetables for the daily replenishment of goods.

DAILY REPLENISHMENT OF GOODS

For the exhibitors of the event, there is the possibility of renting rooms at the venue if you wish to prepare a conference, reception, press conference or product presentation during the fair. It is necessary to make a reservation in advance. Request a free quote without any obligation by emailing uanproduccion@ifema.es

ROOM RENTAL

MORE INFORMATION

2. MANAGE YOUR PARTICIPATION

2.7. Site plan

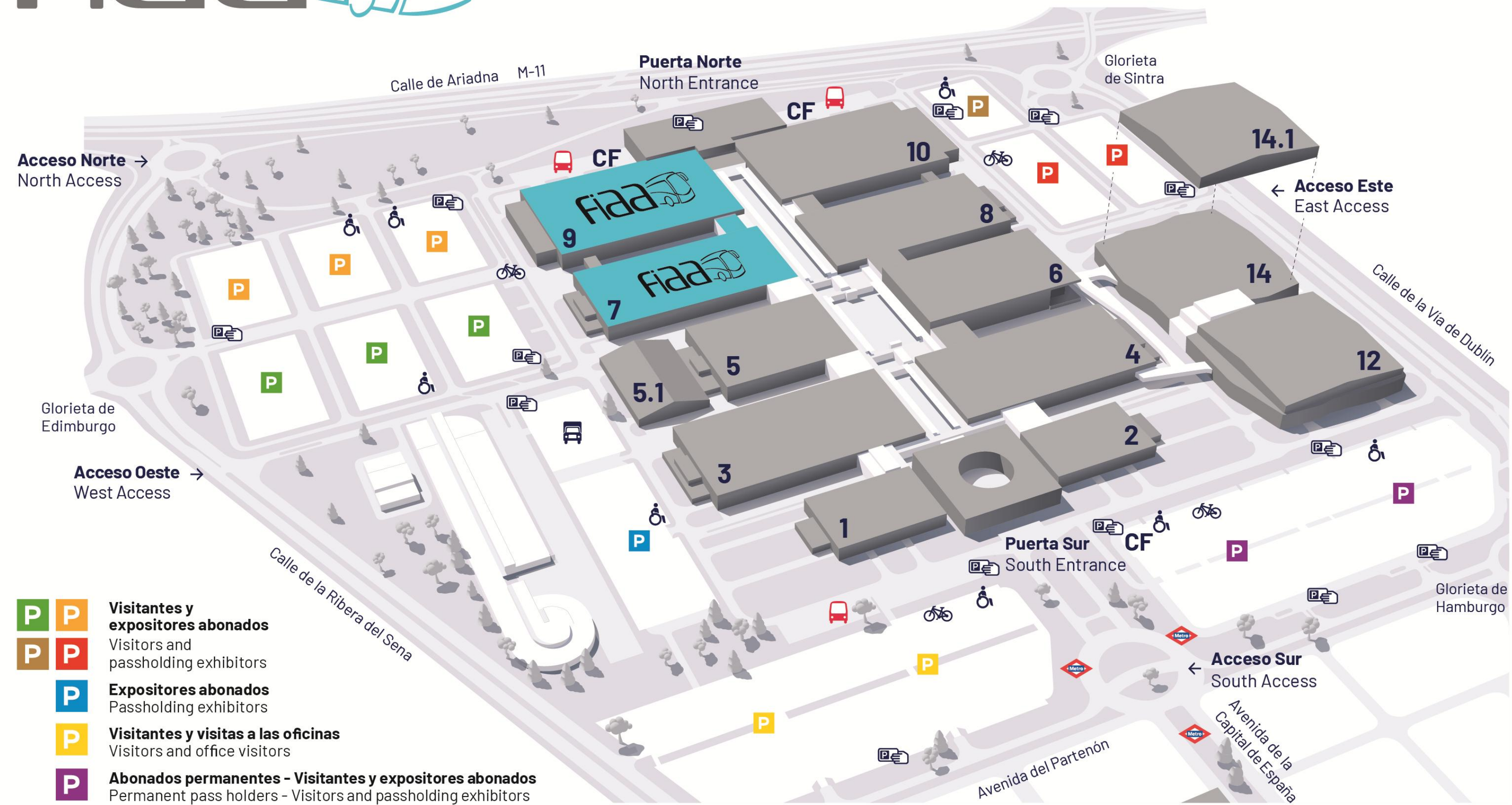

- P P **Visitantes y expositores abonados**
Visitors and passholding exhibitors
- P **Expositores abonados**
Passholding exhibitors
- P **Visitantes y visitas a las oficinas**
Visitors and office visitors
- P **Abonados permanentes - Visitantes y expositores abonados**
Permanent pass holders - Visitors and passholding exhibitors

Cajero aparcamiento
Pay parking

CF Club Feria Oro

Personas con movilidad reducida
People with reduced mobility

Zona Bicicletas
Bicycles Area

Autocares
Coaches

Camiones
Lorries

2. MANAGE YOUR PARTICIPATION

FIAA

2.8. IFEMA MADRID Services

Promote your brand		Phone	Email
On-site and digital advertising	Multiply the presence of your brand and products at the fair. Our advertising team will advise you on the best physical and digital media to achieve the greatest impact.	(+34) 91 722 53 40 (+34) 91 722 53 08	publicidad@ifema.es
Graphic decoration for stands	Customize your modular booth with your brand image. Our team of consultants will help you define the best fit for your booth and follow up on production and installation. You'll have everything ready to go when you arrive.	(+34) 91 722 57 22	decoraciongrafica@ifema.es
Stand design and construction	Do you need a spectacular stand design adapted to your budget? Our partner companies have extensive experience in the exhibition sector and IFEMA MADRID guarantees the quality of their designs and assemblies. Contact us without obligation.	(+34) 91 722 57 22	infodesing@ifema.es
Organize and decorate your space			
Furniture	Make your space a place to work and interact with your customers. Tables, offices, sofas, counters, all adapted to your style and budget.	(+34) 91 722 30 00	atencionalcliente@ifema.es
Refrigeration and cooking equipment	Food preservation and catering solutions for all the activities you want to organize at your stand.	(+34) 91 722 30 00	equiposdefrioycocina@ifema.es
Telecommunications and IT	We have the latest technology in equipment and connectivity to cover all communication needs.	(+34) 91 722 30 00	telecomunicaciones@ifema.es
Auxiliary personnel	We offer you from auxiliary personnel to help you in the assembly to hostesses during the celebration, who will help you to attend your customers in different languages and with the utmost professionalism..	(+34) 91 722 30 00	atencionalcliente@ifema.es

2. MANAGE YOUR PARTICIPATION

FIAA

Organize and decorate your space		Phone	Email
Cleaning and waste containers	Health safety and sustainability are priority commitments for IFEMA MADRID, which is why we provide exhibitors and assemblers with various types of cleaning services and a complete waste management system that meets all environmental standards and health and safety regulations.	(+34) 91 722 30 00	atencionalcliente@ifema.es
Audiovisuals	We have the best equipment for multimedia presentations, sound and translation in stands and rooms.	(+34) 91 722 30 00	atencionalcliente@ifema.es
Support and logistics services			
Transportation and storage	Sending, receiving and storing the merchandise you need for your participation is very easy at IFEMA MADRID. We offer a complete or partial service, national or international, always adapted to your needs.	(+34) 91 722 30 00	atencionalcliente@ifema.es
Driverless forklifts and lifting platforms	If you need to unload merchandise or use special machinery to display your product, we have a wide range of forklifts and lifting platforms to complete any task.	(+34) 91 722 30 00	carretillasdealquiler@ifema.es

3.1 How to make my participation profitable

Participating as an exhibitor at FIAA is a strategic investment to give visibility to your brand, present new products and strengthen commercial relationships. To maximize the return on this investment, it is essential to activate a comprehensive communication plan before, during and after the event. Here are some keys to make your presence profitable.

3.2 Exhibitors Catalog.

The trade show catalog, or list of exhibiting and co-exhibiting companies, is an indispensable promotional and networking tool. It provides visitors and other exhibiting companies with the basic information to prepare for the fair and makes it easier for them to find and contact you before, during and after the event.

- Enter and update your contact details, the products or services presented and the information you consider relevant to give the highest visibility to your company and get the highest return on your participation.
- The entire environment and digital communication of your participation is channeled through Live Connect.
- Take full advantage of the platform offered by IFEMA to communicate your participation, schedule appointments, showcase your products and contact your target audience.

3.3. Networking

Enrich your contact list.

LIVE Connect gives you the opportunity to search for contacts among your participants. You can use filters by country, activity, position, products of interest, etc., to perform searches. Once you have located potential customers, you can ask them to contact you (by sharing information such as email and telephone number). Once they have accepted you, you can chat with them or invite them to a face-to-face meeting at the trade show or by videoconference at the event in LIVE Connect.

Be proactive and take advantage of the opportunity to build a good contact list.

Other users will be able to request meetings by addressing their request either to the company in general (without prior acceptance of the contact) or to a particular team member (prior contact). In this way, the whole team will be able to schedule their schedule of appointments at the fair well in advance.

3.4. LIVE Connect Digital Platform. Other Exhibitor plans.

Being a FIAA exhibitor includes the CONNECT exhibitor plan.

LIVE CONNECT extends the visibility of your brand beyond the days of the fair, allowing you to connect with potential customers throughout the year. The platform facilitates direct contact with professional buyers, generating qualified business opportunities before, during and after the event. With networking tools, meeting scheduling and analysis of interaction, LIVE CONNECT empowers your physical participation with an intelligent and measurable digital experience

3.5. Invitations for your clients and contacts

IFEMA provides you with invitations to the fair to promote your participation efficiently. Be sure to use this useful tool that we make available to you in your Expo Zone.

3.6 Publish your news and novelties. RRSS and WEB

Promote your products, services and news for free through the communication channels that FIAA has such as its website, rrss or newsletters that are sent periodically to a large database of professionals in the bus and coach sector at an international level. FIAA also provides exhibitors with graphic materials so that exhibitors can promote and disseminate their participation in FIAA, such as a customizable banner for email signatures, advertisements and images of FIAA.

3.7 Press Day

The press day on the first day is a strategic opportunity to present your innovations to specialized media and multiply its diffusion from the beginning of the fair. Participating in this day positions you as a protagonist in front of journalists, influencers and industry professionals, generating high-impact media coverage. An outstanding presentation at the press day can translate into interviews, media mentions and reinforced visibility throughout the fair.

For more information jesusg@ifema.es

3.8 Fun afterwork

FIAA 2026 offers the possibility of extending the fair day by holding a recreational afterwork, on September 22, 23 and 24, at the close of the fair, from 7:00 pm until 9:30 pm. It is essential to fill in the application form, which should be requested at fiaa@ifema.es

3.9 Outdoor and digital advertising

Advertising projects tailored to your needs

- Promote your brand before, during and after the event.
- Attract new customers through the best B2B targeting in the market.

More information here: [Advertising | IFEMA MADRID](#)

See also the advertising options offered by the LIVE Connect platform. de las mejores segmentaciones B2B

del mercado.

3.10 Room Rental

For the exhibitors of the event, there is the possibility of renting rooms at the venue if you wish to prepare a conference, reception, press conference or product presentation during the fair. It is necessary to make a reservation in advance.

Request a quote: (+34) 91 722 30 00 uanproduccion@ifema.es

4. SUSTAINABILITY CUTURE MANAGEMENT AT IFEMA MADRID

FIAA

At IFEMA MADRID we are not only fully committed to sustainability per se, but also to achieving the sustainable development goals (hereinafter SDGs) promoted by the United Nations, which we have incorporated into our strategic corporate management policy and culture

IFEMA MADRID's sustainability policy is mainly focused on the following SDGs: 8, 9, 11, 12, 13, 16 and 17.

IFEMA MADRID'S sustainability policy is mainly based on the following SDGs: Nos. 8, 9, 11, 12, 13, 16 and 17.

ISO Standards certified by IFEMA MADRID:

- ISO 9001: Quality Management,
- ISO 20121: Event Sustainability Management.
- ISO 14001: Environmental Management,
- ISO 50001: Energy Management,
- ISO 22320: Emergencies Management.

ACTIONS TAKEN AT IFEMA MADRID TO REDUCE GAS EMISSIONS AND BE MORE ENERGY EFFICIENT:

- 100% certified electrical energy of renewable origin.
- Geothermal installation in Puerta Sur building.
- Low consumption lighting in our halls and on our modular stands.
- Controlling the temperature of our air-conditioning / HVAC systems.

IFEMA MADRID is in possession of "calculo" (I calculate) and "reduzco" (I reduce) stamps in Carbon Footprint Scopes 1 and 2.

WASTE MANAGEMENT:

- The exhibitor/assembler is the generator of the waste and shall therefore be responsible for its removal and management. How the waste generated by the exhibitor is managed is explained in article 35 of the General Rules of Participation.
- We offer our exhibitors a service that includes the removal and management of the waste they/their assemblers generate. (check our fees in Exhibitors' Area).

CARPET RECYCLING:

IFEMA MADRID recycles 100% of the carpeting used in aisles and communal areas. To do so it has been essential to change our assembly and disassembly process, that affects the entry and removal of goods (check the corresponding item) . Furthermore, means that it has to be laid in strips instead of covering the entire surface area as was previously the case. This means we can guarantee its conversion into a new raw material for the subsequent manufacture of other products.

SUSTAINABLE MOBILITY:

IFEMA MADRID offers access to public transport close to its facilities (metro and bus), parking for electric cars with 100% renewable electricity charge points, as well as a parking area for bicycles and scooters

GUIDE TO SUSTAINABLE PARTICIPATION IN TRADE FAIRS/EVENTS:

IFEMA MADRID has published its Guide to Sustainable Participation in Trade Fairs for exhibitors on its website. We recommend you read it before starting to prepare your participation:
ifema.es/en/about-us/quality-sustainability



2.6. FAQ's

Question	Answer
<p>Where can I consult the IFEMA MADRID General Rules of Participation to which my participation is subject?</p>	<p>In addition to the Exhibitor's Guide, participation in Salón Look is subject to IFEMA MADRID's General Rules of Participation, which you should be informed about and which you can access on the IFEMA MADRID website (www.ifema.es) and via the following link IFEMA MADRID General Rules of Participation.</p>
<p>Can I hire a catering service or serve my own food and beverages at the stand?</p>	<p>Yes. Exhibitors who are going to offer a catering service at their stand (free of charge), can do so either by submitting their application with the approved catering companies at IFEMA MADRID (See the list HERE) or through other catering service providers, in which case it is essential to fill in the form "Notification for the provision of catering services on stands" available in the exhibitors' area of the institutional website and send it, with the information requested therein, to: catering@ifema.es for its information and appropriate ends.</p> <p>If IFEMA MADRID has not been notified, the Exhibitor will not be able to offer this service on their stand.</p> <p>The Exhibitor assumes responsibility for third-party complaints that are caused by said catering service, and expressly exempts IFEMA MADRID from any liability in this regard.</p>
<p>Can I access the trade fair centre with vehicles for assembly and disassembly or loading and unloading of goods?</p>	<p>Access to IFEMA MADRID and to the inside of the halls will be done through the doors and on the days and times stated in this Exhibitor's Guide. The inside of pavilions will only be accessed to unload materials. Vehicles will not be able to park inside the halls or in the adjacent areas. We would like to remind you that, for safety reasons, it is strictly forbidden to park directly in front of the goods entrance.</p> <p>IFEMA MADRID takes no responsibility for the surveillance of vehicles while they are on the grounds of Feria de Madrid.</p> <p>There is a car park for trucks and another for private cars, which can be used by paying, where appropriate, the corresponding fees. Check rates</p>
<p>Can I have a vehicle on my stand?</p>	<p>Vehicles with a combustion engine used as part of an exhibition display must have a tank filled with the minimum fuel required to access the allocated space and be able to leave it at the end of the exhibition.</p>

2.6. FAQ's

Question	Answer
<p>Can I send goods to my booth?</p>	<p>IFEMA MADRID staff are not authorised to receive merchandise for your stand. In order to send merchandise to the venue, the exhibitor must indicate the delivery address: IFEMA MADRID (Avda. del Partenón, 5. 28042 Madrid. Spain). Salón Look Trade Fair Name of your company. Hall and stand number.</p> <p>The merchandise must be received by your company's staff at your stand and arrive on the days set aside for incoming merchandise and decoration. If it is not possible to comply with the above, we recommend that you contact your freight forwarding partner: DB Schenker office at the IFEMA Trade Fair Centre MADRID: Hall 7, (+91) 330 51 77 ifema.madrid@dbschenker.com</p>
<p>What procedure do I have to follow to hang structures in the halls/rigging?</p>	<p>Exhibiting companies may hang elements from the ceiling of the halls following the procedure shown in the "Regulations for hanging structures in Halls" and by completing the form "Application for authorisation for hanging structures/rigging" and sending it to: rigging@ifema.es</p>
<p>Can I hold prize draws and raffles at the stand?</p>	<p>Raffles, prize draws, and random combination games are forms of gambling as set out in articles 3.2 and defined in article 15 of Law 6/2001 of 3 July on gambling in the Community of Madrid.</p> <p>All the information is available in the following form: https://sede.comunidad.madrid/comunicaciones-declaraciones/cifras-tombolas</p>
<p>How do I apply for a visa support letter?</p>	<p>Visa support letters are managed through the EXPO ZONE. To do so, you first have to personalise your exhibitor passes. Once you have managed your exhibitor passes, you can request your support letters and download them to your computer.</p> <p>It is essential to be up to date with payments according to the payment schedule in order to be able to apply for the letters.</p>
<p>Where can I book the services for my stand?</p>	<p>Either through the e-commerce section inside the EXPO ZONE or via the link: https://shop.ifema.es</p>
<p>Who do I contact to book a room?</p>	<p>Exhibitors who need to book a room should contact with: uanproduccion@ifema.es</p>

Question	Answer
What does the CONECTA PLAN include?	<p>This compulsory contracting concept includes the following services:</p> <ul style="list-style-type: none">• Dissemination of the participation in the fair through insertion in the list of exhibitors accessible in open access on the fair's website and shared in communications.• Presence during the fair on the hall plans and lists of exhibitors on display.• Presence as exhibitors in the digital event of the Salón Look trade fair with 10 products or services associated with the company file.• Access to IFEMA MADRID's 'ZONA EXPO' customer portal to manage participation.• Exhibitor passes according to the contract (see point 2.3).• Online invitations according to the contract (see point 2.3) and delivery service through the EXPO ZONE.• Discount vouchers for transport.• Premium wifi connection for 3 users during the whole fair (5 GHz devices). Access codes will be sent the days prior to the start of the fair.• Access to the digital platform Salón Look for 3 users with connection functionalities to generate business opportunities.
How to use the EXPO ZONE?	<p>The following video shows a tutorial on the use of the EXPO ZONE</p>
What are the features of my EXPO ZONE?	<p>It is used to manage the participation of each exhibiting company at Salón Look</p> <ul style="list-style-type: none">• Registration of contacts who are going to access the Expo Zone and management of access permissions.• Access to the exhibitor's calendar.• View documents of interest.• Manage exhibitor passes, request visa support letters and send invitations.• Access to payments, statement of accounts and invoices issued.• Upload free design stand projects and distribution of modular stand elements.• Add signage for exhibitors with modular stands.• Access to e-commerce for contracting services

Question	Answer
<p>What are the features of the Salón Look digital platform?</p>	<p>In the exhibitor area of my company on the digital platform:</p> <ul style="list-style-type: none"> • Update the company data visible in the catalogue and digital event of Salón Look. • Display the range of products and services on offer. • Manage the company's appointment schedule for professional meetings at the stand. • Register other team members with access to the digital platform. <p>At the digital event:</p> <ul style="list-style-type: none"> • Complete my personal profile on the platform and my agenda of availability for meetings. • Search for contacts of interest in the professional network and request and accept to be a contact for chat and videoconferences. • Scan professional badges at the trade fair. • View information on what other exhibitors have to offer. • Consult the activities with the possibility of scheduling them and viewing the digital content available.
<p>How can I request my invoices?</p>	<p>Invocas are not generated by default. You must request them directly from the IFEMA MADRID invoicing department (servifema@ifema.es) indicating the event at which you are exhibiting and the items to be included in the invoice. Once it has been generated, it will be available in your Expo Zone.</p>
<p>What is the difference between the floor only option and the modular stand option?</p>	<p>The floor-only modality only includes the contracting of the space and the compulsory elements (insurance, minimum electricity consumption and the CONECTA EXHIBITOR PLAN, and it is the exhibitor who has to create a free-design stand or contract it through the stand design service offered by IFEMA MADRID.</p> <p>The modular stands are delivered assembled. See description in section 1.6</p>

2. MANAGE YOUR PARTICIPATION

2.6. FAQ's

Question	Answer
Can I decorate and/or set up my stand with IFEMA MADRID?	<p>Yes, IFEMA MADRID offers two main services:</p> <p>Graphic decoration for stands: Customise your modular stand with your brand image for maximum visitor impact. There is a wide range of versatile graphic materials adaptable to walls, furniture, front, banners... You can request information and a quote at: decoraciongrafica@ifema.es. In case of a Premium Modular Stand contact standspremium@ifema.es</p> <p>Stand design: this consists of a comprehensive stand design service fully adapted to your needs. From the planning of your space, design, assembly and disassembly. You can request information and a quote at: standbuilding@ifema.es</p>
Is it compulsory to attend the booth at all times?	<p>Yes, exhibitors must not leave their stand unattended and must remain with the products on display throughout the entire period and opening hours of the event.</p>
Are assembler's passes necessary during the set-up of the trade fair?	<p>No. The requirements to be allowed to enter and set up are: to have paid 100% of your participation, to have the project presented and approved, to have paid the assembly fees, and to have completed the occupational risk protocol.</p>
How can I book parking at IFEMA MADRID?	<p>Exhibiting companies will be able to book parking spaces through the e-commerce section inside the EXPO ZONE or via the link https://shop.ifema.es.</p>

2.6. FAQ's

Question	Answer
What coverage do I have as an exhibitor with the insurance included?	You can check the coverage of the compulsory insurance policies at the IFEMA MADRID exhibitor support area .
How can I access the WI-FI network as an exhibitor?	As an exhibitor you will receive as part of the CONNECT PLAN a Wi-Fi connection for 3 users during the entire trade fair for the exclusive use of stand holders. Devices that allow 5GHz network capability are required. Access codes will be sent out during the lead up to the event. Additional Wi-Fi access can be booked through the e-commerce section inside the EXPO ZONE or via the link https://shop.ifema.es
Regulations and support for exhibitors at the trade fair centre	https://www.ifema.es/en/support/exhibitors-ifema-fairgrounds
Regulations and support for fitters at the trade fair centre	https://www.ifema.es/en/support/assemblers-colaborators-fairgrounds

Department	Ask about	Contact		
Address of the contest	<ul style="list-style-type: none"> • Space contracting • General topics of participation in the fair • Exhibitor passes • Professional visitor invitations • Activities and forums at the fair 	Director	David Moneo	(+34) 91 722 30 00 fiaa@ifema.es
		Comercial Manager	Vicente Toldos	
		Comercial Area	Magalí Durán	
IFEMA MADRID Customer Service	<ul style="list-style-type: none"> • Hiring of services • Expo Zone • Visitor information 	(+34) 91 722 30 00 atencionalcliente@ifema.es		
Technical Secretariat (Directorate of Trade Fair Services)	<ul style="list-style-type: none"> • Technical support to exhibitors and assemblers. • Review of stand assembly projects. • Solutions to technical problems during the fair activity • Customization of modular stands • Coordination of catering services in stands. 	(+34) 91 722 30 00 stecnica@ifema.es		
Graphic decoration	<ul style="list-style-type: none"> • Hiring of graphic materials to customize your booth 	(+34) 91 722 30 00 decoraciongrafica@ifema.es		
Full service stand design	<ul style="list-style-type: none"> • Design and assembly of free design stands 	(+34) 91 722 30 00 standbuilding@ifema.es		

Departament	Ask about	Contact		
Outdoor Advertising	<ul style="list-style-type: none"> Hiring of advertising media at the fairgrounds 	(+34) 91 722 53 40/08 publicidadexterior@ifema.es		
Communications Management	<ul style="list-style-type: none"> Media relations 	<table border="0"> <tr> <td> Director: Raúl Díez Head of Press: Jesús González International Press: Elena Valera Press Secretary: Beatriz Sánchez-Heredero </td> <td style="text-align: right; vertical-align: top;"> (+34) 627 70 60 73 jesusg@ifema.es </td> </tr> </table>	Director: Raúl Díez Head of Press: Jesús González International Press: Elena Valera Press Secretary: Beatriz Sánchez-Heredero	(+34) 627 70 60 73 jesusg@ifema.es
Director: Raúl Díez Head of Press: Jesús González International Press: Elena Valera Press Secretary: Beatriz Sánchez-Heredero	(+34) 627 70 60 73 jesusg@ifema.es			
Directorate of Planning and Control	<ul style="list-style-type: none"> Rental of the different meeting and convention spaces at the fairgrounds, both during and outside the fairs. Coordination of extra-fair activities 	(+34) 91 722 30 00 uanproduccion@ifema.es		
Institutional Relations (Protocol)	<ul style="list-style-type: none"> Institutional visits Guided tours Protocol for all events Institutional relations 	(+34) 91 722 30 00 infoifema@ifema.es		
Safety and Self-Protection Management	<ul style="list-style-type: none"> General security and parking Fairground accesses 	(+34) 91 722 50 65 dseguridad@ifema.es		
Medical Service and Security Emergencies	<ul style="list-style-type: none"> Medical emergency Health care for exhibitors and visitors during the celebration of fairs, set-up and dismantling. 	(+34) 91 722 54 00		

Thanks

